

THE FILTER-FEEDING AND FOOD OF FLAMINGOES  
(PHOENICOPTERI)

BY PENELOPE M. JENKIN

*Department of Zoology, Bristol University*

(Communicated by D. Lack, F.R.S.—Received 4 April 1956—  
Revised 10 August 1956)

[Plates 14 to 17]

CONTENTS

	PAGE
INTRODUCTION	404
1. Species of flamingoes and their distribution	405
2. The problem	405
3. Acknowledgements	407
4. Material	407
MORPHOLOGY	409
5. Structure of the bill	409
5.1. Shallow-keeled bills of <i>Phoenicopterus</i>	413
5.2. Deep-keeled bills of <i>Phoeniconaias</i> and <i>Phoenicoparrus</i>	415
6. Structure, size and variation of the lamellae	421
6.1. Lamellae of flamingoes with shallow-keeled bills	426
6.2. Lamellae of flamingoes with deep-keeled bills	434
7. Structure of the tongue and palate	446
7.1. Tongue and palate of <i>Phoenicopterus</i>	446
7.2. Tongue and palate of <i>Phoeniconaias</i>	448
7.3. Tongue and palate of <i>Phoenicoparrus</i>	449
8. Sense organs on the bill and tongue	449
8.1. Sense organs of <i>Phoenicopterus</i>	449
8.2. Sense organs of <i>Phoeniconaias</i> and <i>Phoenicoparrus</i>	450
OBSERVATIONS	450
9. Behaviour and bill movements in feeding	451
9.1. Feeding in the field	451
9.2. Feeding and other behaviour of <i>Phoenicopterus</i> in captivity	452
9.3. Movements of the bill of <i>Ph. antiquorum</i>	452
9.4. Movements of the tongue of <i>Ph. antiquorum</i>	453
10. Kinds and size of food eaten	453
10.1. Food of flamingoes with shallow-keeled bills	454
10.2. Food of flamingoes with deep-keeled bills	459
11. Size of grit collected in the gizzard	461
DEDUCTIONS	463
12. Identification of structures used for filtration of food and grit from the water and for exclusion of larger particles during feeding	463
12.1. Filters and excluders in shallow-keeled bills	464
12.2. Filters and excluders in deep-keeled bills	468

	PAGE
13. Reconstruction of the processes of filtration and the variations that must be postulated in different circumstances and species	471
13.1. Process of filtration when <i>Ph. antiquorum</i> feeds upon whole organisms	472
13.2. Process by which <i>Ph. antiquorum</i> feeds upon mud	473
13.3. Processes of feeding in <i>Ph. ruber</i> and <i>Ph. chilensis</i>	474
13.4. Process of filtration when <i>Ph'naias minor</i> feeds upon diatoms or minute algae	474
13.5. Process of filtration in <i>Phoenicoparrus</i>	477
DISCUSSION	478
14. Effects of filter-feeding upon the ecology of flamingoes	478
14.1. Effects of filter-feeding on their diet	478
14.2. The distribution of flamingoes in relation to habitats that meet their ecological needs	480
14.3. The place of filtration in overcoming physiological problems that arise from feeding in brackish and alkaline waters	486
15. Affinities and evolution of flamingoes	488
REFERENCES	490

The Greater Flamingo, *Phoenicopterus antiquorum*, feeds by filtering chironomid larvae, seeds, etc., from mud; the Lesser Flamingo, *Phoeniconaias minor*, has a much finer filter, previously undescribed, by which it feeds on the blue-green alga, *Spirulina platensis*, and diatoms. The two flamingoes can therefore feed in the same lake without competing for food.

Data from observations on living birds, from detailed anatomy of the bill, and from analyses of stomach contents of birds feeding in localities with known ecology, have been used to elucidate the process of filtration in these species, seen in Kenya, and in *Phoenicopterus ruber*, *Ph. chilensis*, *Phoenicoparrus andinus* and *Ph'parrus jamesi*, of the New World.

The **bill structure** is of two distinct types, though always bent in the middle, with the lower jaw large and trough-like and the upper small and lid-like. The shallow-keeled upper jaw of *Phoenicopterus* is as wide as the lower; the gape is at the side, crossed by distal outer lamellae curling downwards to prevent its closing completely. The inner surface carries a concave lamellated area on either side of the keel, but does not touch the similar area on the convex, inflexed border of the lower jaw. The deep-keeled upper jaw of *Phoeniconaias*, and *Phoenicoparrus*, is much narrower and lies flush between the rami of the lower; the dorsal gape is crossed by horizontal, distal outer lamellae. Internally, the upper jaw has a deep keel that is flat-sided, so that in section it is an equilateral triangle. The flattened, inflexed borders of the lower jaw turn downwards for 15 mm parallel with the sides of the keel throughout the length of the gape; the central tongue-groove is thereby much constricted. These flat lamellated areas, three times the size of those of *Phoenicopterus*, are in close contact across the gape. Bills of the three species of *Phoenicopterus* are much alike; those of *Ph'naias minor* and *Ph'parrus andinus* are similar in form and size; that of *Ph'parrus jamesi* is shorter, with a narrow upper jaw and consequently reduced lamellated areas. Measurements show much individual variation.

The **lamellae** are horny thickenings running transversely across the lamellated areas; they form smooth ridges, serrated ridges, or separate triangular platelets, fibres of which may separate to form a fringed edge projecting towards the tongue. Their variations in form, size and spacing, in different parts of the bill and from species to species, are described and illustrated with figures and tabulated measurements. **Outer lamellae**, near the margins of the upper jaw, are large leaflets or hooks projecting across the gape: vertically, to form the **filter** in shallow-keeled bills; horizontally, to form the **excluder** in deep-keeled bills. They are fringed, in species with fringed inner lamellae. Outer lamellae of the lower jaw are smaller and less distinctive but subdivide the filter in *Phoenicopterus*. They are integrated with the inner lamellae in other genera. **Inner lamellae** are smaller and more closely spaced than outer. On the lower jaw of *Phoenicopterus* they form smooth or serrated ridges; on the upper jaw they form platelets, diagonally alined to leave channels leading inwards and backwards from gape to tongue. In *Phoeniconaias* and *Phoenicoparrus* most inner lamellae on both jaws form small, tall, closely set platelets, also diagonally alined, making a velvety

pile on the flat lamellated areas. The platelets of *Ph'parrus andinus* are smooth, those of *Ph'naias minor* and *Ph'parrus jamesi* are fringed; all form **fine-meshed filters**, small in area in the last-named.

The **tongue** and **palate** in *Ph. antiquorum* are larger than in *Ph'naias minor*; they have a similar armature of spines directing food towards the gullet, and a transverse epiglottis. The tongue is large and fleshy; the distal half, packed with oily fat, has only the thin hypoglossus muscle below the broad lingual cartilage; the other muscles are straight and confined to the base, and aid its fore and aft pumping action. The bill is reputed to be rich in **tactile organs**; Herbst corpuscles occur under the dorsal surface of the upper jaw of *Ph'naias minor*, but are rare under the inner lamellae. Their position in *Phoenicopterus* is uncertain. A large olfactory foramen suggests that there may be a well-developed 'oral' sense to be investigated.

*Ph. antiquorum* feeds in bottom mud, whereas *Ph'naias minor* sweeps near the water surface. Both use a 'jig' movement to stir particles off the bottom; in *Ph. antiquorum* this is also associated with eating mud. Birds in captivity show the jaw movements and the forceful tongue pulse, expelling jets of filtered water four times a second. Records of the kinds and sizes of food organisms, mostly based on stomach contents, are tabulated for all species. In *Phoenicopterus* the kind of food varies widely (contrary to the belief that *Ph. ruber* eats only the gastropod *Cerithium*); but the size is between 1 and 10 mm in length. Claims that they also feed on algae are dubious; but *Ph. antiquorum* and *Ph. ruber* can survive, and feed their young, on organic mud. In East Africa healthy specimens of *Ph'naias minor* always feed on blue-green algae or diatoms, with dimensions between 0.02 and 0.1 mm. Entomotrachea or water-mites are probably eaten by *Ph'parrus andinus*, and algae of unknown dimensions by *Ph'parrus jamesi*, but the evidence is inconclusive. Analysis by British Standard Sieves shows that 80% of the grit from gizzards of *Ph. antiquorum* measures more than 0.5 mm, and from *Ph'naias minor* less than 0.5 mm.

To identify the **structures used in filter-feeding**, their sizes are compared systematically with those of the grit and food. For *Phoenicopterus*, grit provides the more exact measure, and food confirms it; for *Phoeniconaias*, diatoms taken from the stomach provide the exact measure. In *Phoenicopterus* the **filter** is formed across the practically closed gape by the outer hooks and leaflets on the upper jaw, aided by the intermediate submarginals above and the serrated ridges on the margin of the lower jaw below. All the spaces then have one dimension less than 0.5 mm, except near the tip of the bill, where the minimum increases to 1.0 mm. This is commensurate with the smallest dimensions of most of the food (theoretically, cylindrical objects could be caught by any mesh smaller than their longest dimension, i.e. 3 to 5 mm in this case). The **excluder** must be formed by opening the gape to about 4 or 6 mm at the bend, the shape of which prevents the tips from separating as widely as they would in a straight bill. In *Ph'naias minor* the fine **filter** is formed by fringes on the inner platelets enclosing spaces measuring 0.01 by 0.05 mm. The **excluder** is formed by the outer lamellae, with spaces measuring about 1.0 by 0.4 mm. The same structures give a **filter** measuring 0.005 by 0.05 mm and an **excluder** of 2.5 by 0.25 mm in *Ph'parrus jamesi*; the intermediate **filter** in *Ph'parrus andinus* is formed by smooth platelets with spaces measuring between 0.3 by 0.06 mm and 1.2 by 0.14 mm. This filter therefore has spaces smaller than the smallest of those in *Ph. antiquorum*, but linear dimensions about ten times larger than those in *Ph'naias minor*. The **excluder** is also intermediate and has dimensions between 1.5 by 0.7 mm and 2.5 by 1.0 mm.

There is no direct evidence on the **process of filtration** within the closed bill in its inverted feeding position; but the filters and excluders already identified are correlated with the movements of the jaws and tongue to postulate three methods of feeding, differing with the kind of food and the type of bill.

(i) When *Phoenicopterus*, with its shallow-keeled bill, feeds on whole organisms, water is actively pumped by the tongue through the stationary **outer lamellar filter**, while the bill is swept through the water to reach new food supplies. Raising the upper jaw admits the food through the narrow gape, acting as excluder; closing the bill re-forms the filter. The inner lamellae may help to detect and hold organisms in the bill.

(ii) But when *Phoenicopterus* feeds on mud, the process is reversed and apparently ceases to be true filtration, for there is no filter fine enough to retain mud, which must therefore be gulped down together with admixed brine. The **outer lamellae** form the **excluder** for the coarse sand, which is then left in cones marking the feeding places.

(iii) When *Ph'naias minor*, with its deep-keeled bill, feeds on algae, the upper jaw must not move far, for its **outer hooks and leaflets** form the **excluder**; the tongue pumps water, carrying food, inwards along channels between the diagonally aligned inner platelets. Pressing the extensive lamellated areas together, on one side of the bill at a time, helps to force the outgoing water through and around the **filtering fringes** of the **inner lamellae**. The volume of water moved by each tongue stroke about fills the deep gape; it will therefore oscillate about the filters, rather than be drawn through them for long distances in either direction; small vortices will help to entangle and retain the food. This is collected from the filters by rubbing them up and down on each other, like collecting wool from 'carders'; thus it is brought within reach of bristles on the tongue. Filtration in *Phoenicoparrus* is presumably similar.

It is suggested that the reversed use of marginal hooks as excluders, when *Phoenicopterus* feeds on mud, may be a clue to the evolution of the deep-keeled species, which combine this use of the marginals with use of the inner platelets as a fine filter. There is no fossil evidence upon this point and little upon the evolution of the flamingo's bill as a whole, with its many specializations. The suborder had most of its present characteristics in the Miocene, except the bend in the bill, which still appears late in individual development. The affinities of flamingoes with other birds are certainly obscured by their specialization for filter-feeding, in which they are only rivalled among adult vertebrates by the whale-bone whales (Mysticeti).

Like other microphagous species, flamingoes have only a choice of size of organisms but not of kind. Since flocks are large, food requirements are enormous; their distribution is therefore strongly influenced by the search for habitats where such food occurs in abundance. This means arid localities, with brackish or alkaline waters, where the few species which can withstand the ecological rigours of the situation can multiply sufficiently, whether they be *Artemia*, *Cerithium* or *Spirulina*. Thus flamingoes congregate near the great deserts of the world, often at high altitudes. The ecological advantage of these habitats in providing food is offset by the damaging effects of their waters, which differ greatly in salt content and ionic balance from the bird's body fluids. The physiological importance of the part played by filtration in reducing the volume of the medium ingested with the food is stressed.

## INTRODUCTION

It has rightly been assumed for a long time that the bill of the Greater Flamingo is elaborately adapted to filter-feeding, and that it provides the best, if not the only, parallel among birds to the analogous system in the whale-bone whales, such as *Balaena* (e.g. Stejneger 1885, p. 153). Both are adult air-breathing vertebrates with secondary modifications within the mouth, enabling them to feed by filtration under water; otherwise filter-feeding among living vertebrates is practically confined to the young stages of lampreys, where it might be considered primitive, and to some fish and *Xenopus* larvae. Despite the rarity of the phenomenon in adults, details of filtration appear to have been lacking, and the fact that other species of flamingo have even more highly adapted filtering systems than that of the Greater Flamingo has passed almost unnoticed until now. This is, perhaps, the more surprising in view of the publicity which certain flamingoes have lately received; but attention has more often been focused on their nesting and on the risk of their extermination by egg-hunters, than on their feeding habits; on the beauty of their plumage, than on details of their anatomy. Both Gallet (1949) and Yeates (1950) have indeed raised the controversial subject of the flamingo's ability to subsist upon mud; but both their books deal only with the Greater Flamingo in the south of France (*Phoenicopterus antiquorum*) and give no details about the feeding of the other five species, four of which belong to the New World. Six, that is, if Peters's (1931, p. 141) classification is accepted; but some authors (e.g. Witherby, Jourdain, Ticehurst & Tucker 1939) prefer to group them as four species, one of which is divided into three subspecies.



## I. SPECIES OF FLAMINGOES AND THEIR DISTRIBUTION

The suborder Phoenicopteriformes, according to Peters (1931, p. 141) whose classification is followed here, contains six species belonging to three genera:

*PHOENICOPTERUS* Linné, the Greater Flamingo:

*Phoenicopterus antiquorum* Temminck, 1820.

*Ph. ruber* Linné, 1758.

*Ph. chilensis* Molina, 1782.

*PHOENICONAIAS* Gray, 1869, the Lesser Flamingo:

*Ph'naias minor* (Geoffroy), 1798.

*PHOENICOPARRUS* Bonaparte, 1856, the Andean Flamingo:

*Ph'parrus andinus* (R. A. Philippi), 1854.

*Ph'parrus jamesi* (Sclater), 1886.

Since the similarity of these three generic names is liable to cause confusion, the abbreviations *Ph.*, *Ph'naias* and *Ph'parrus* will be used, as indicated above, to make them as distinctive as possible.

*Ph. antiquorum* Temminck is the Greater Flamingo of the Old World, and is distributed from the Mediterranean to India and Lake Baikal; it is most frequent in muddy lagoons near the sea coast, as in the French Camargue (Gallet 1949), the Nile Delta, the Chotts of North Africa (Domergue 1949, p. 119) and Walvis Bay in South-West Africa; it also occurs in smaller numbers on brackish inland waters, and was the less abundant of the two species which I saw in 1929 on alkaline lakes in Kenya. Witherby *et al.* (1939, p. 163) give reasons for relinquishing Temminck's specific name in favour of the subspecific name *Ph. ruber roseus* Pall., 1811; but Yeates (1950, p. 188), while discussing this bird's distribution in some detail, confuses the nomenclature by referring to it as *Ph. ruber ruber* and using *Ph. ruber roseus* for the American subspecies, which Peters calls *Ph. ruber* Linné. The latter occurs on lagoons on the Atlantic coast of Central America, the Bahamas and other West Indian islands, including Inagua.

*Ph. chilensis* Molina (or *Ph. ruber chilensis*) is widespread in southern South America, chiefly around salt lakes. *Ph. ignipalliatus* Geoff. & D'Orb., 1832 is a synonym for this species.

*Ph'naias minor* (Geoffroy) occurs in north-west India and in Africa, where it has been recorded inland, from the south, from Madagascar, the Cameroons and possibly Senegal, as well as from East Africa, where it occurs mostly, if not exclusively, round alkaline and brackish waters; it was the more abundant of the two species in Kenya. *Ph'naias rubidus* (Feild.), 1868 is a synonym, based on a female specimen (Hume 1872, p. 32).

*Ph'parrus andinus* (Philippi) occurs chiefly on salt lakes in the High Andes of Argentina and Chile, and is said to be replaced farther north in Chile and in Peru by the rare *Ph'parrus jamesi* (Sclater). Both species have been reported from Bolivia, but the second does not appear to have been seen for certain since the beginning of this century.

## 2. THE PROBLEM

It is now many years since I worked on some alkaline lakes in Kenya, where *Ph. antiquorum* and *Ph'naias minor* fed side by side in large flocks without, as is now known, competing for food. *Ph'naias minor* was much the more abundant of the two, and I was able to

establish for the first time, from specimens shot by Mr (now Dr) D. G. MacInnes, that it fed on fine blue-green algae (Jenkin 1929, p. 574; 1936, p. 149). The possibility of so small an organism forming the staple diet of such large birds had previously only been surmised in rather indefinite terms (Jackson 1938, p. 93). Although I was not able to obtain any evidence on the food of *Ph. antiquorum* in 1929, my observations on the food of *Ph'naias minor* received a certain amount of publicity shortly afterwards, partly because Professor Julian Huxley visited our camp near Lake Nakuru, and referred to them in a subsequent account of his travels (Huxley 1933, p. 247), and partly because I described my findings to the meeting of the British Association in South Africa, later in 1929. On my return to Cambridge, some excellent sections of the bill of *Ph'naias minor* (figures 11 and 13) were cut for me by the late Mr G. Drury, and from these it was at once apparent that this species of flamingo had a most beautiful and hitherto undescribed filtering system of fringed platelets lining the bill. These provided a far finer mesh of filter than anything possessed by *Ph. antiquorum*, and appeared to be commensurate with the algal food. The outline of these facts was demonstrated to the Society for Experimental Biology at Plymouth in 1933, and I added details, revealed by the use of the polarizing microscope, for the same Society at Bristol in 1948. Thence the statement that 'some flamingoes feed wholly on blue-green algae, collected by a filter system on the jaws, using a current of water produced by the sucking mouth and piston-like tongue', found its way into Young's text-book (1950, p. 444), in anticipation of the present detailed treatment of the subject.

Attempts to obtain specimens of *Ph. antiquorum*, while feeding on the Kenya Lakes, were very kindly made for me by Dr D. G. MacInnes in 1929 and again in 1934, but all failed because these birds were shy and always kept a crowd of the Lesser Flamingo between themselves and his approaching gun; nor could any risks be taken, as both species were very strictly preserved and we only had a licence to collect two of each. My investigation of the structure of the filtering system in *Ph. antiquorum* was therefore carried out on two specimens that died in captivity in this country, but led to the conclusion that it must be almost, if not quite, impossible for this species to collect the fine algae that formed the food of *Ph'naias minor*. It was not until December 1952 that Ridley & Percy (1953, p. 108) obtained fresh material of both species from Lake Elmenteita, which gave the long-sought-for evidence that, whereas *Ph'naias minor* had eaten the expected mass of algae, *Ph. antiquorum* had still only collected relatively large objects, such as insect larvae, copepods and sedge seeds. The two flamingoes, therefore, provide yet another example of a pair of species, which can co-exist without competing with one another, because of a size difference in their food requirements (Hutchinson 1951, p. 572).

Meanwhile Mr W. B. Alexander encouraged me to investigate the four American species of flamingo, and I found from preserved heads that *Ph. ruber* and *Ph. chilensis* have bills and lamellae closely similar to those of *Ph. antiquorum*, while the two species of *Phoenicoparrus* are strikingly similar to *Ph'naias minor*, even in fine details which had never been described. The present account of the morphology thus covers all six species and brings together what is known of the structure of the bill, my own observations and measurements on the horny lamellae lining the bill, and a brief description of the tongue, palate and sense-organs.

The details of the form, sizes and spacing of the lamellae given below may seem excessive; but they have proved necessary in coming to any satisfactory conclusions as to which

structures could act as filters and which as excluders. The problem remained as to how these structures were actually used in filtration, since neither direct observation of processes occurring within the box-like bony bill nor any form of experimentation seemed possible. The solution lay in comparing the sizes of the particles of food and grit that the birds collected, with the sizes of spaces between the lamellae, and relating these to the known movements of jaws, tongue and water currents. While the interpretations arrived at seem to fit most of the facts, there remains a degree of variation in form and size of lamellae in different parts of the bill for which no certain function has been established.

As so often in the study of functional morphology, the detailed consideration of this problem has inevitably led on to speculation on the relation between such remarkable feeding adaptations and the ecology, distribution and evolution of this highly specialized suborder of birds.

### 3. ACKNOWLEDGEMENTS

It is a pleasure to record my great indebtedness to many who have helped me at one stage or another. I am most deeply indebted to Lord Richard Percy and the Hon. Matthew Ridley not only for their freely shared observations and material, without which my evidence was incomplete, but also for generously allowing me to see their report (Ridley, Moss & Percy 1955) in manuscript. I also wish to thank the officers of the Zoological Societies of London and Clifton for specimens of *Phoenicopterus*; the Trustees, British Museum (Natural History), for allowing me to examine specimens of all three genera; Dr David Lack, F.R.S. and the Rev. P. H. T. Hartley for stimulating and expert suggestions and criticisms in a field of biology with which I was then unfamiliar; to Dr A. McC. Bidder and Dr H. P. Whiting for reading much of my manuscript and making valuable criticisms and comparisons with cognate problems of functional morphology in other forms; and not least to Professor J. E. Harris for introducing me to the polarizing microscope and discussing many of my ideas. For the photographs reproduced in the plates, the reader will be as grateful as I am to those experts who made them, Messrs G. L. E. Wing and J. K. Wood of the Zoological Department of Bristol University. Finally, any zoologist, who has shared with me the privilege of studying under the late Dr Hans Gadow, will understand my pleasure in finding myself following for a time in his early footsteps (see '*Anatomie des Phoenicopterus roseus*', Gadow 1877), and adding a stone to the cairn of his studies in the comparative anatomy of vertebrates.

### 4. MATERIAL

Observations on living flamingoes were made on flocks of *Ph'naias minor* and some *Ph. antiquorum* in Kenya. The former cannot be kept alive in captivity, probably because of its peculiar food requirements, and I have not seen it since 1929, except in an excellent film of Mr Ridley's. *Ph. antiquorum* and *Ph. chilensis* have been watched at close quarters while feeding in the Zoological Gardens in London and Clifton.

#### *Fresh, preserved and dried heads*

Specimens have been examined from various sources, by kind permission of the authorities concerned, to whom I am much indebted: the British Museum (Natural History), London (prefix B); the Strickland collection in the Zoological Museum, Cambridge

(prefix C); and Mr Ridley's collection in the Hancock Museum, Newcastle (prefix R); other specimens have come into my possession from the sources noted below (prefix J). All are the heads of dried skins unless otherwise stated.

*Ph. antiquorum*. Ca to Ce are adults of unrecorded sex, of which measurements were made. J3 (figures 1 and 3a, and 20, plate 14) is a head of an old adult from Clifton Zoological Gardens, received through the courtesy of the Superintendent. I examined it fresh, shortly after its death; it was then preserved in formalin. J4 is a similarly preserved head of a juvenile female which had died shortly after importation to the London Zoological Gardens, and was received through the courtesy of Dr E. Hindle.

*Ph. ruber*. B541 (figure 3b) and B542 are adult females, 99.9.1.541 and 542; B546 is an adult male, 99.9.1.546, all from Galapagos, 1897. The bills were stiff, but two were sufficiently open to show the lamellae under a low-power binocular.

*Ph. chilensis*. B4 is a spirit specimen of an adult of this species, labelled *Ph. ignipalliatu*s Geoffr. & D'Orb. (p. 405), 4.7.11.1928. I was allowed to make preparations of some lamellae. B8 is an adult, 1903.12.8.8, from Patagonia. Cf is an adult, which had 'died in captivity', and had abnormally long upper marginals. J15 is a preserved head of an adult received from Clifton Zoological Gardens in 1955 (figure 3c).

*Ph'naias minor*. Cr is the type of *Ph'naias rubidus* (Feild.), 1868 (p. 405). It is an adult from India. J1 and J2 (figure 5) are heads of adults from Lake Nakuru, Kenya, preserved in 1929. J5 to J13 are heads of various ages from the same locality. They were preserved in 1934, by the kindness of Dr MacInnes, but only reached me in 1946, after drying up; the sexes are unknown. R792 is an adult male, R813 and R823 are juveniles; all three are preserved heads kindly presented to me by Mr Ridley. R805 is a young male; R806 is a young female; R809 and R827 are adult males, and R820 is an adult female, all from Kenya. These I was allowed to examine and measure in Newcastle.

*Ph'parrus andinus*. B214 (figure 6b) is an adult female, 91.9.9.214, and B216 is an adult male, 91.9.9.216, from the salt marshes near Cancosa, 1890. The bill of the female was at one time wide open, and gave a good view of the structure and of the lamellae, apart from some areas where they were damaged. The male bill had the more complete set of marginal lamellae. Two other specimens were also examined from the same collection.

*Ph'parrus jamesi*. B57 (figure 6c) is an adult, 57.10.9.1; B92 is an adult female, 92.2.10.398, collected by Rahmer from 'Sitani, 21.1.86'. These bills are almost closed; but the essential structure can be seen. I am much indebted to the Curator of Birds for permission to isolate and mount a few inner lamellae from both species of *Phoenicoparrus*.

#### Skulls

Dr MacInnes kindly lent me one skull of *Ph. antiquorum* and one of *Ph'naias minor*; skulls of *Phoenicopterus* were received from the Anatomy Department of Bristol University, and Lord Richard Percy kindly lent me another, with the hyoid bones well preserved.

#### Stomach contents

Fresh material from *Ph'naias minor* that had been feeding on Lake Nakuru was examined in the field in 1929, and samples were preserved in formalin. Nine stomachs were preserved from specimens that had been feeding on the same lake in 1934; despite subsequent

desiccation they yielded a quantity of diatoms. Their grit contents have been analyzed by British Standard Sieves.

Lord Richard Percy and Mr Ridley have shown me samples of food and similarly analyzed samples of grit collected in 1951 and 1952 from both *Ph'naias minor* and *Ph. antiquorum*.

## MORPHOLOGY

Flamingoes swing their heads down to the level of their feet to feed, and this movement naturally turns the head and bill upside down; but, although this peculiar position is characteristic, the structure of the bill and its lamellae will be described in the normal orientation.

### 5. STRUCTURE OF THE BILL

The external form of the bill of all species of flamingoes has often been described and figured (e.g. Gray 1869, pp. 438 to 443 and plates XIII to XV); but, since these and other figures are neither as accessible nor as consistently named as they might be, little excuse need be made for repeating the relevant facts here, together with new figures and details of the internal structures (figures 1 to 6).

The bill is very large in proportion to the sleek head, and is sharply bent down near the middle of its length to give that haughty appearance, which has rightly earned for *Ph. antiquorum* an Arabic name meaning 'Camel-of-the-sea', a name that would indeed be equally applicable to any species of flamingo (e.g. figures 20 and 23, plate 14, facing p. 476). The lower jaw is much larger than the upper in all species; but the shape of the jaws differs in different species (cf. figures 3 and 6). In life, the bill is brightly coloured in strongly contrasted shades of pink, orange, yellow or magenta and black, according to the species.

In all species the horny layer covering the bill is unusually soft; it can therefore give little strength to these bills for feeding, as compared with those of most seed-eating birds.

The horn at the tip of the bill forms no true 'dertrum' or hard shield (Plate 1922, p. 263); nevertheless, the horn thickens gradually into a relatively hard area, which is arched from side to side on the upper jaw and bends down over the tip of the bone, like a long fingernail; horn also forms a sharp edge to the tip of the lower jaw (figures 20 and 23, plate 14). The horn lining the bill forms the lamellae (§ 6), which extend across sharply delimited 'lamellated areas' on both jaws (e.g. Ps, figure 2).

The osteology of the skull has been described in detail for *Ph. ruber* (Shufeldt 1901, pp. 297 et seq. and plates X and XI); the cranium appears to be essentially similar, not only in *Ph. antiquorum* (figure 2) but also in *Ph'naias minor* (figure 4), although the bills are so different. The bones of the skull are so cancellous and fenestrated that the skull is remarkably light for its size, thereby probably facilitating more rapid movements in feeding than would be possible with a more massive structure. In many places the internal cavities in the bone (see sections, plate 14) even appear as pits on the surface (figure 4a), owing to lack of the covering of compact bony tissue present on most birds' skulls (Shufeldt 1901, p. 298).

The skull is mesokinetic like that of many related forms; the bill can therefore be opened by raising the upper jaw as well as by dropping the lower. Figure 2 illustrates the method by which the movement is transmitted from the quadrate (*q.*) to the upper jaw, formed of

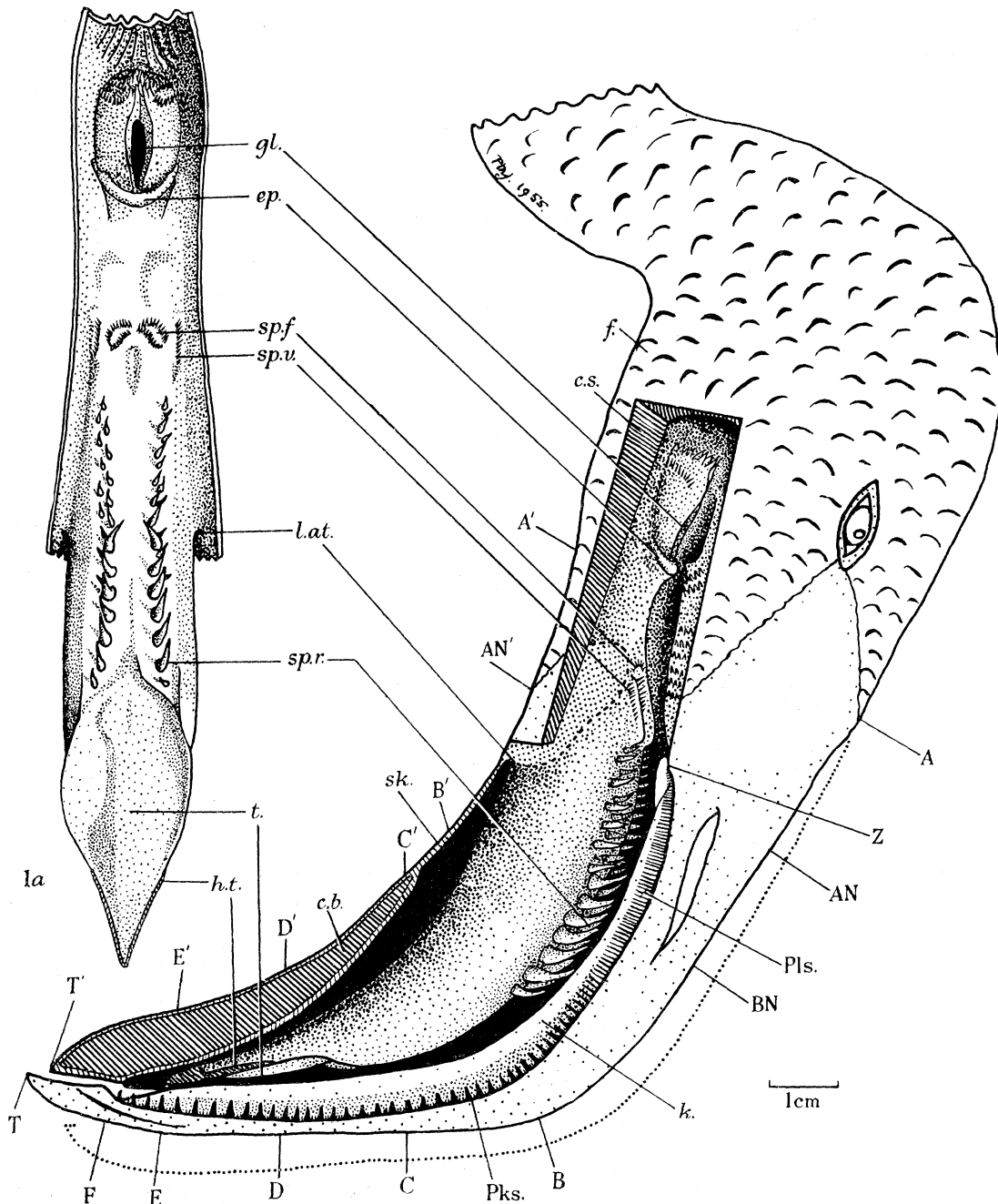

FIGURE 1. Head of *Ph. antiquorum* (J3), shown with its shallow-keeled bill closed for filtering. The extent to which it is opened in feeding (as in figure 2) is indicated by the dotted line. The right ramus of the lower jaw has been cut away to expose the mouth cavity, the tongue and the keel (*k.*) on the upper jaw. *1a*. Upper surface of the tongue, flattened out. A-A' to T-T', the transverse planes used in measuring the bill and lamellae (pp. 412-413); *c.b.* cut surface of bony fusion between the rami of the lower jaw; *c.s.* cut surface of skin and muscle round lower jaw; *ep.* epiglottis; *f.* feathers extending to A dorsally and AN' ventrally; *gl.* glottis; *h.t.* horny plate underlying the tip of the tongue; *k.* keel, hiding inflexed border of lower jaw behind; *l.at.* limit of attachment of tongue to the floor of the mouth cavity; Pks, marginal hooks forming main part of filter; Pls, marginal leaflets, forming proximal part of filter; *sk.* skin of 'naked throat' unsupported by bone from AN' to near C'; *sp.f.* double fan of spines on tongue; *sp.r.* large recurved spines on tongue (cf. figure 17*a*); *sp.v.* vertical spines at the side of the tongue; *t.* flattened area of tongue, with raised edges; Z, posterior limit of lamellated area.

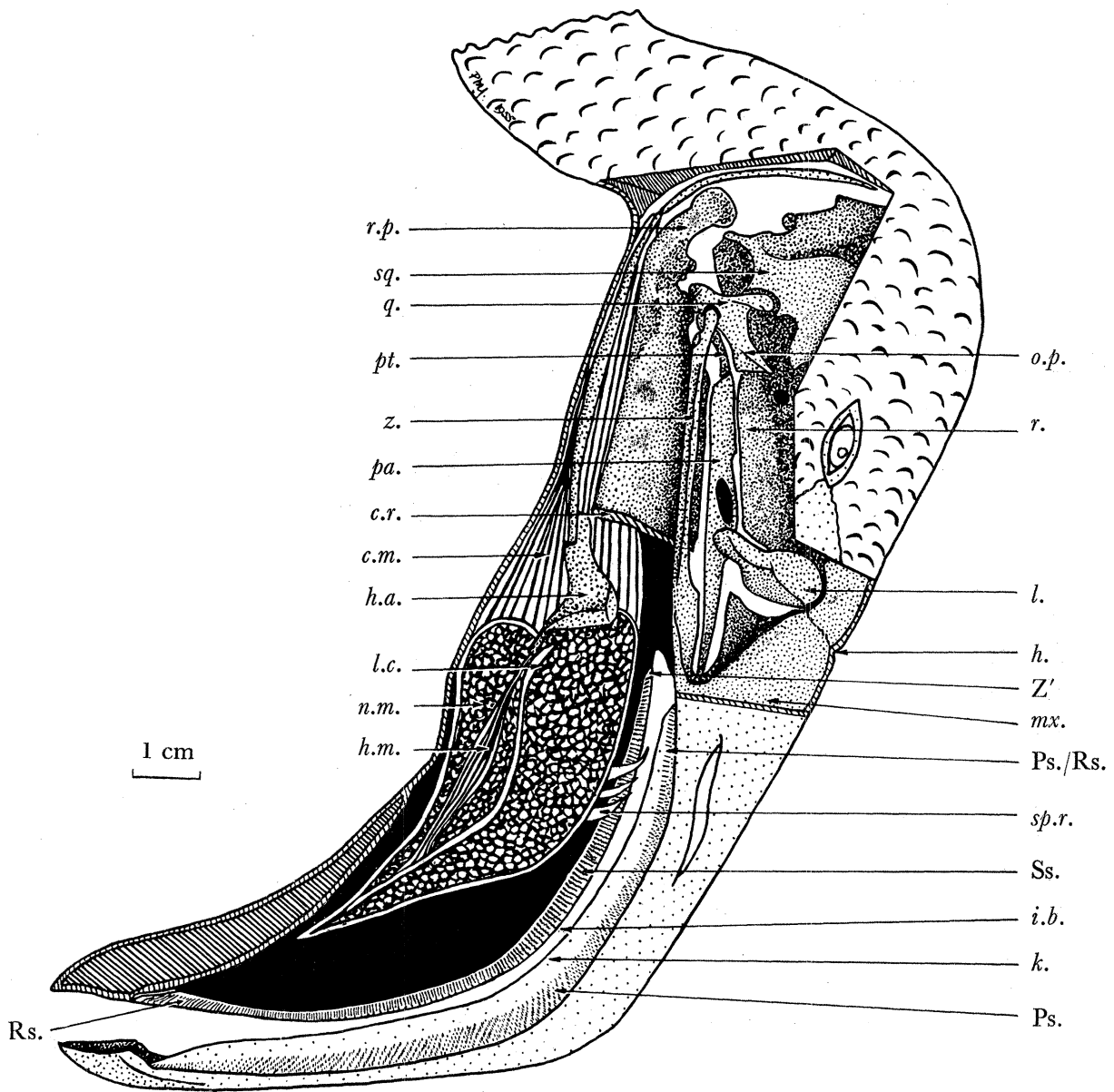

FIGURE 2. Dissected head of *Ph. antiquorum* with the bill open, and right ramus of lower jaw cut away at *c.r.* Marginal hooks and leaflets (Pks and Pls in figure 1), and all but the three most distal recurved tongue spines, *sp.r.*, have been omitted for clarity. The finely stippled skeleton shows the means of raising the upper jaw about the fibrous hinge, *h.*, by contraction of muscles attached to long processes, *o.p.*, on the quadrate, *q.*, which rocks on the squamosal, *sq.*, and transmits its thrust to the maxilla, *mx.*, both through pterygoids, *pt.*, and palatines, *pa.*, and through the zygoma, *z.* The tongue, with its hyoid apparatus, *h.a.*, is withdrawn by contraction of the muscles, *c.m.*; its non-muscular part, *n.m.*, supported by the lingual cartilage, *l.c.*, is bent by contraction of the hypoglossus muscle, *h.m.*, to increase the mouth cavity and suck in food. Inner lamellae on the inflexed border, *i.b.*, of the lower jaw with retro-articular process, *r.p.*, form smooth ridges, Rs, or serrated ridges, Ss. Inner lamellae on the lamellated area of the keel, *k.*, are partially, Ps/Rs, or wholly, Ps, subdivided into smooth platelets (cf. figure 7). The lachrymal bone, *l.*, has the large olfactory foramen between it and the rostrum, *r.*

fused maxillae (*mx.*), premaxillae and nasals. The palatines have a long sliding articulation with the under-side of the 'rostrum' (*r.*), formed of the parasphenoid fused with the inter-orbital septum and the base of the cranium. The pterygoids also have a short anterior articulation with the skull, but basipterygoid processes are absent from the otherwise typically desmognathous palate. This movement was early postulated by Grew (1681, p. 68) in a vivid description of a 'Phoenicopter'; the 'shape and bigness of the upper Beak (which here, contrary to what it is in all other Birds that I have seen, is thinner and far less than the nether) speaks it to be more fit for motion and to make the appulse and the nether to receive it. But there can be no determination of these matters, without inspection into the Muscles and the Articulation of the Bones'. Despite this sound advice, the 'inspection' of the muscles has never been carried out in full for the flamingo, though a certain amount about the mechanism may be deduced from direct observation of the movements (§ 9·3). Kripp (1933, p. 541 and figure 44) deduces from graphical analyses that the movement of the upper jaw can be very rapid in the cormorant (*Phalacrocorax*) because the angle between the axis of the quadrate and that of the bones connecting it to the upper jaw is very nearly a right angle. This ensures the maximum jaw movement for any given angular displacement of the quadrate; the same must hold true for the flamingo, where movement is also very rapid (cf. *g.* and *z.*, figure 2).

The bones of each ramus of the lower jaw are completely fused and the rami are also firmly fused to one another for some distance (figures 4*b* and *c*). This gives the jaw considerable rigidity despite the cancellous nature of the bone. The post-articular process (*r.p.*, figure 2) is very large, as in some Anseres, but unlike the Ciconiids, which flamingoes resemble in so many other ways. This may be related to opening the large lower jaw, when in the feeding position, against the force of gravity. Kripp's (1933, p. 541) contention, that the lower jaw muscles can force the quadrate, and therefore the upper jaw, forward and upward as the lower jaw is opened, may also apply here; nevertheless, the jaws appear to be independently movable (§ 9·2). The quadrate-articular joint between the upper and lower jaws has a decided ball-and-socket form (to which my attention was drawn by Dr H. P. Whiting), and is therefore quite unlike the almost flat articular surface characteristic of most ducks, geese and storks. This may serve to prevent the dislocation of the jaw joint, during the energetic fore-and-aft drive of the tongue in feeding.

For ease of comparison the same system of measuring the bill will be applied in turn to all the species.

#### *Measurement of the bill*

Transverse planes along the length of the bill are taken to pass, at right angles to its upper surface, through the following points on the upper jaw (figures 1 and 4):

- A, the edge of the feathers at the base of the bill,
- AN, the proximal limit of the nostril,
- BN, the distal limit of the nostril,
- B, midway round the bend,
- C, D, E, one-quarter, one-half and three-quarters of the distance from B to the tip, respectively,
- F, the proximal end of the horny tip,
- T, the extreme tip.



The same planes pass on through the lower jaw, when the bill is closed, at points indicated by the same letters with a dash, A', B', etc.

Z and Z' indicate the proximal limits of the lamellated area on the upper and lower jaws respectively.

The **length** (*l*) of the bill is taken as the direct length from A to T. It depends upon the angle of bend being constant; this it apparently is, within narrow limits, in adult birds. The length of the **culmen** or 'dorsal ridge of the upper bill' (Newton & Gadow 1893, p. 33) is not easy to measure accurately, round the bend; but it is often the only measurement quoted by other writers. The **breadth** (*b*) of either jaw at any given point is taken by caliper measurement. The **height** (*h*) of either jaw, in any given transverse plane, is intended to be the greatest vertical distance (when the plane of bilateral symmetry is vertical) between the level of the dorsal (or ventral in the case of the lower jaw) surface and the level of insertion of the marginal lamellae. This also is not easy to measure, and is admittedly rather subjective; it seems to be of no particular functional significance, though it shows small differences between the sexes. All bill measurements are expressed in centimetres, usually to the nearest 0.05 cm (tables 1 and 2).

The bills of flamingoes fall into two sharply contrasted groups, on account of their internal shape; the shallow-keeled type of *Phoenicopterus* and the deep-keeled type of *Phoeniconaias* and *Phoenicoparrus*. The distinctive features of the two types are listed below with references to the figures illustrating each feature.

	shallow-keeled bills of <i>Phoenicopterus</i>	deep-keeled bills of <i>Phoeniconaias</i> and <i>Phoenicoparrus</i>
upper jaw below the bend (B to T, 1 and 4a):*	wide, covering the lower jaw, visible in profile (20)	narrow, slipping between the rami of the lower jaw, invisible in profile (23)
gape:	at the sides of the bill (8 and 20)	on dorsal surface of the bill (6 and 12)
distal outer lamellae:	vertical (8 and 22)	horizontal (11 and 25)
keel on upper jaw:	shallow, with wide central strip uncovered by lamellae (8 and 21)	deep, flat-sided, almost completely covered by lamellae (11, 12, 24 and 25)
inflexed borders of lower jaw:	curled over and narrow (2, 4c, 8 and 22)	turned down inwards at a sharp angle, with a wide, flat surface (4b, 12, 24 and 25)
lamellated areas:	small (2)	relatively large, except in <i>Ph.parrus jamesi</i> (5 and 6a to c)
rami of lower jaw:	only fused from T' to B'; widely separated from B' to AN' (1 and 4c)	fused from T' to AN' (4a and b)
tongue:	relatively free, in large space within lower jaw (1 and 21)	restricted, in close-fitting space (5 and 24)
'throat':	'naked' (1 and 20)	'feathered' (5 and 23)
filter (see § 12):	coarse (18a)	relatively fine (19a)

\* Numbers in brackets refer to figures; 20 to 25 are on plate 14, facing p. 476.

### 5.1. *Shallow-keeled bills of Phoenicopterus*

#### *The bill of Phoenicopterus antiquorum*

The best published description with an original drawing is in Plate's text-book (1922, p. 261 and figure 235E and F). The **shallow keel** (*k.*, figure 2) runs in the mid-line along the inner surface of the upper jaw. It is well marked in section (figures 21 and 22,

plate 14), but is definitely shallow in comparison with the deep keel of *Phoeniconaias* (figures 24 and 25, plate 14). Grew (1681, p. 67) refers to the keel as 'an Angle, or sharp Ridge, which runs all along the middle'. It is deepest near the bend, B, and gradually flattens out towards the throat, and also diminishes as it narrows towards the tip of the bill. It separates the inner surface of the upper jaw longitudinally into two areas, which are slightly concave from side to side along their whole length. The outer half of each is the **lamellated area** (Ps and Ps/Rs, figure 2), which carries lamellae. The two rami of the lower jaw are only fused together for 5 or 6 cm from T' to B', to form the bony floor of the mouth. Proximal to B' is an area of soft unfeathered skin (*sk.*, figure 1), the 'naked throat'; it underlies the tongue muscles and allows them relatively free play (figures 20 and 21,

TABLE 1. MEASUREMENTS OF THE BILLS OF *PHOENICOPTERUS* SPP.

The method of measurement in centimetres, corrected to 0.05 cm, is given on pp. 412-413, and the positions A, T, BN, etc., are shown on figure 1. *l* = length, *h* = height and *b* = breadth, ad. = adult, juv. = juvenile stage, m. = male and f. = female.

species	...	<i>Ph. antiquorum</i>		<i>Ph. ruber</i>		<i>Ph. chilensis</i>
specimen	...	J3†	J4	B546	B542	B8†
sex and age	...	ad. f.?	juv. f.	m.	f.	ad.
<i>l</i> : AT		13.0	12.0	12.2	12.1	11.0
BT		8.2	7.5	7.0	6.95	7.0?
<i>h</i> : upper at BN		1.1	1.2	1.0	1.0	1.15
upper at B		0.9	0.85	0.6	0.6	0.85
lower at BN'		3.0	2.7	2.5	2.1	2.5
lower at B'		2.9	2.6	2.8	2.5	2.25
total at BN		4.1	3.9	3.5	3.1	3.65
total at B		3.8	3.45	3.4	3.1	3.1
<i>b</i> : upper at BN		1.9	1.6	2.0	1.9	1.65
upper at B		2.0	1.7	2.1	2.1	1.85
upper at D		2.3	1.7	1.5	1.7	1.9
upper at F		0.65	0.55	0.68	0.61	0.75
lower at B'		2.4	2.3	2.7	2.7	2.52
lower at D'		2.3	2.1	1.9	2.45	2.45
'culmen'*		14.2		13.3		12.7

\* Measurement given in inches in British Museum Catalogue (Salvadori 1895) for the same species.

† Comparable though less complete measurements for *Ph. antiquorum*, Ca (AT=11.4 cm), Cb (AT=12.6 cm), Cd (AT=13.2 cm) and for *Ph. chilensis*, Cf (AT=10.7 cm), are deposited at the British Museum (Natural History) London.

plate 14). The lamellated areas on the lower jaw correspond in breadth and extent to those on the upper and are supported by Grew's (1681) 'hollow... Margins, strangely expanded inwards for the breadth of above a quarter of an inch and somewhat convexly'. These expanded margins are here called **inflexed borders** to avoid confusion with the even more expanded borders of the deep-keeled bills. They curl smoothly over inwards from the dorsal edges of the rami from Z' to F' (figures 2 and 4c and 21 and 22, plate 14). 'Marginal' is retained for their lateral edges).

The upper jaw is as broad as, or in places even a little broader than, the lower (figure 3a); it fits over the latter like the lid of a box, leaving the gape at the sides of the bill, with the marginal lamellae hanging down vertically across the gape (figure 20, plate 14) and preventing its closing completely (p. 431). In profile, the upper jaw can therefore be seen above the lower throughout its whole length.

Bills of seven specimens showed considerable variations in size; J 3 and J 4 in table 1 are intermediate in most dimensions between *Ca* and *Cd* (p. 408). The length of 14.2 cm is given for the culmen by Salvadori (1895, p. 15); Witherby *et al.* (1939, p. 166) give a range of 12.0 to 13.5 cm for the bill length of twelve specimens of *Ph. antiquorum*, without specifying how this is measured. The total length AT of my measurements ranged from 11.4 cm for *Ca* to 13.2 cm for *Cd*. These specimens provide no clear information upon differences in size or proportion of the bill due to age or sex. According to Hume (1872, p. 35), who examined many specimens in India, that shown in Gray's figure 2 (1869, p. 439 and plate XIII) as a supposed Indian variety, is a female of *Ph. antiquorum* and that in his figure 1 is a male; from these it appears that the sex differences are slight.

#### *The bill of Phoenicopterus ruber*

There is very little difference except in colouring between the bills of this species and either of the others of the same genus; a fact which is taken by some authors as part of the evidence for considering them all as subspecies of the one species. The length of 13.3 cm given in the British Museum Catalogue for the culmen makes it appear considerably smaller than that of *Ph. antiquorum*; but the three specimens of *Ph. ruber* examined (p. 408 and figure 3*b*) had bills intermediate in length between those given for *Ph. antiquorum* (table 1 and figure 3*a*). Thus the size range of the two species must at least overlap, if it is not substantially the same.

#### *The bill of Phoenicopterus chilensis*

The bills of this species appear to be rather shorter than those of the two preceding species, but only three specimens of unknown sex have been measured. The length of 12.7 cm given for the culmen is also small. The measurements of the height and breadth are intermediate between those of the other two species, rather than being proportional to the length (table 1 and figure 3*c*).

### 5.2. *Deep-keeled bills of Phoeniconaias and Phoenicoparrus*

#### *The bill of Phoeniconaias minor*

The most obvious external difference between the shallow-keeled (p. 413) and deep-keeled bills is that the upper jaw of the latter is much narrower than the lower (figure 6*a*, cf. *b* at D and D', table 2). Between B and F it sinks between the rami of the lower jaw, until its upper surface is flush with theirs; in profile it is therefore only visible above the bend and at the tip (figure 23, plate 14). The gape consequently appears on the dorsal surface (figure 6*a*), and faces the substratum in the inverted feeding position. The row of marginal platelets formed from outer lamellae conform to this by projecting laterally across the gape.

The **deep keel** (*k.*, figure 5) is most distinctive, as Geoffroy (1798, p. 97, figures 3 and 6) made clear when he first described the species as '*Phoenicopterus minor*'; but it has raised no subsequent comment, even from Gray (1869, p. 440), when he transferred the species to *Phoeniconaias*. The keel is drawn down into so large and flat-sided a structure that it converts the cross-section of the upper jaw (figures 24 and 25, plate 14) into an almost equi-

lateral triangle. The large, flat **lamellated areas** extend almost to the free edge of the keel, leaving a strip, only 1.5 mm deep, free of lamellae (*e.*, figure 5). The keel extends backwards to BN, before gradually flattening out over the throat; it also decreases in depth forwards.

The **expanded inflexed borders** (*i.b.*, figure 5) on the lower jaw also carry large lamellated areas. They form relatively large shelf-like structures, partly overhanging the trough occupied by the tongue (figures 4*b* and 24 and 25, plate 14). The mid-ventral fusion of the two rami of the lower jaw extends almost to AN' (*f.r.*, figure 4*a*) instead of stopping short at B', as in *Phoenicopterus*; this provides a stiff floor to the tongue groove, which thereby becomes almost tubular. The tongue fits into it so closely as to suggest

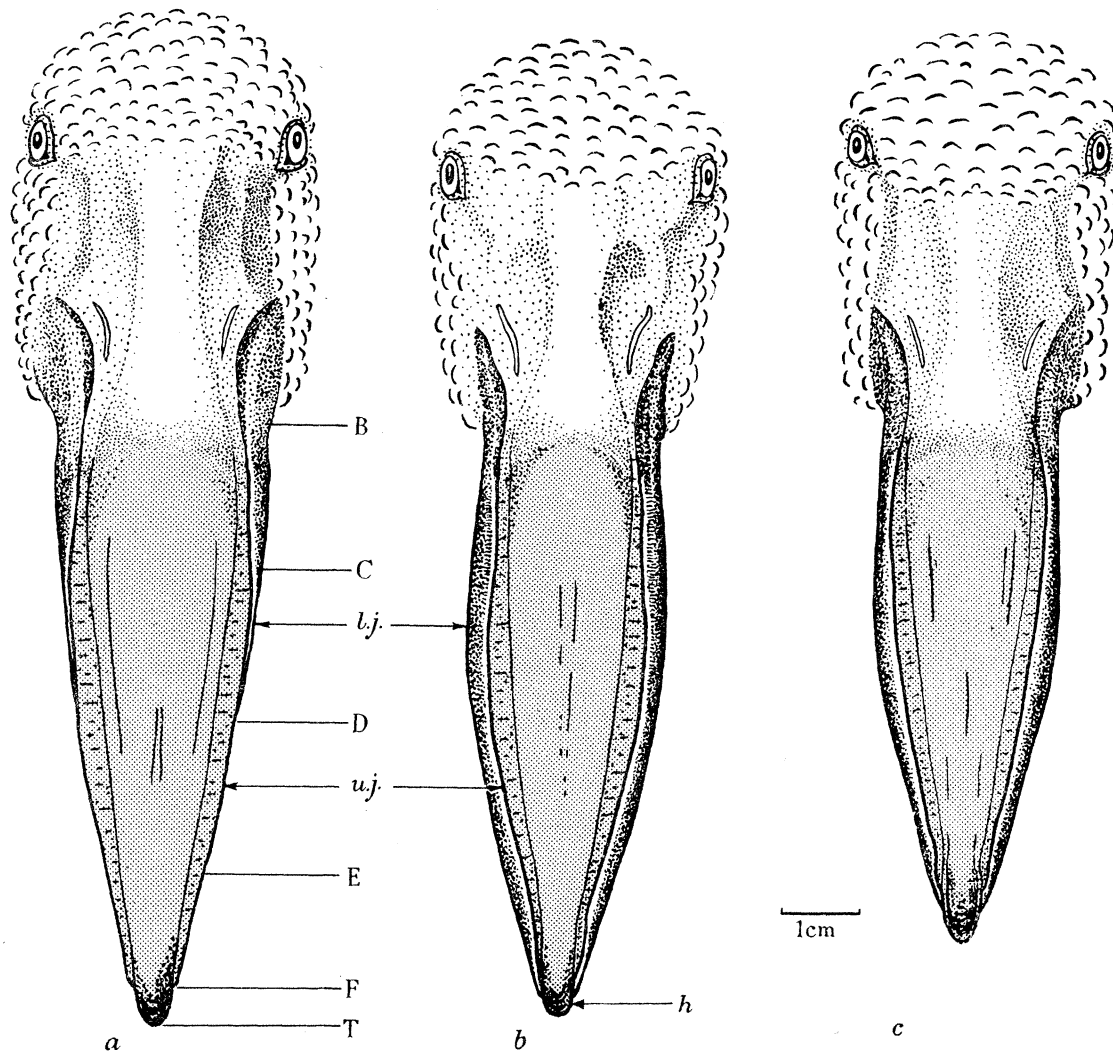

FIGURE 3. Front view of heads of *Phoenicopterus*, chiefly to show the relative sizes and shapes of the upper and lower jaws in shallow-keeled bills, from the bend, B, to the tip, T. Positions B to T are the same as in figure 1. The upper jaw, *u.j.*, is wide and nearly covers the lower, *l.j.*; the outer lamellae are invisible in this view of these species, in contrast to those shown in figure 6. The horn, *h.*, at the bill tip is curved and thick. (a) *Ph. antiquorum*. Old specimen from Clifton Zoological Gardens, J3. (b) *Ph. ruber*. Adult female from the Galapagos, B 541. (c) *Ph. chilensis*. Adult specimen from Clifton Zoological Gardens, J15 (AT, 10.5 cm; BT, 6.7 cm). It is rather smaller than B 8 (table 1).

a piston in a curved cylinder. The bony fusion of the rami (figure 4a and b) also accounts for the 'feathered throat' (Salvadori 1895, p. 8), used to distinguish this species and *Phoenicoparrus* from *Phoenicopterus* spp., with their so-called 'naked throat'. It is not the feathers which differ; in all three genera they reach to the same point on the throat near AN'. It is the skin distal to this point which is unsupported by bone in *Phoenicopterus* and is

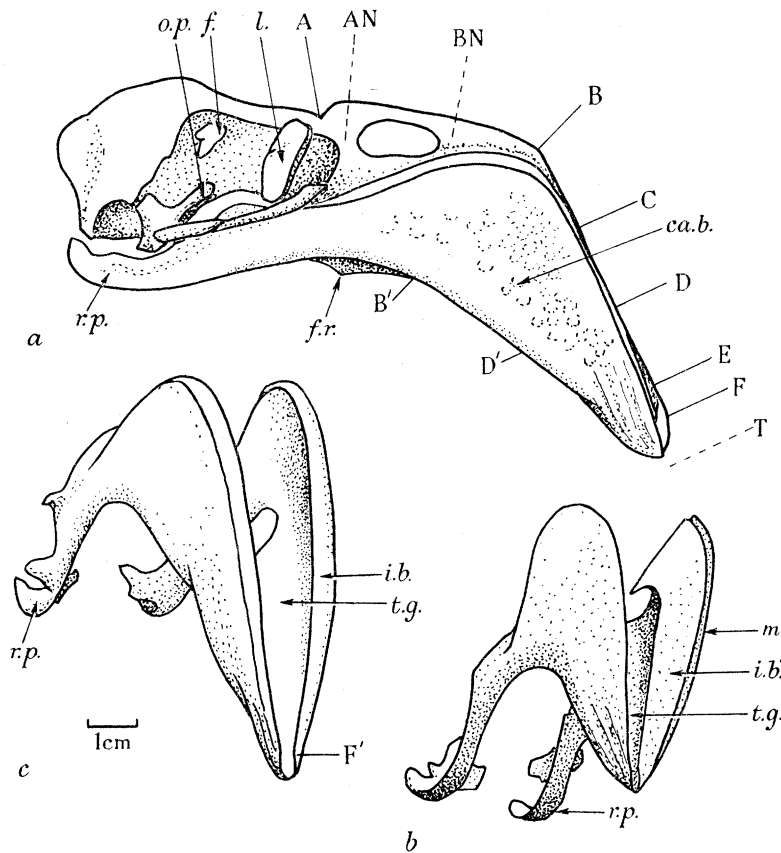

FIGURE 4. (a) Skull of *Ph'naias minor* in profile. (b) Antero-lateral view of the fused bones of the lower jaw of *Ph'naias minor* to show the deep, flattened inflexed borders, *i.b'*., of the deep-keeled bill. (c) Antero-lateral view of the bones of the lower jaw of *Ph. antiquorum*, to show the narrow border, *i.b.*, curled inwards in this shallow-keeled bill. A, the point of flexure between the cranium and the upper jaw; AN to F, positions of transverse planes in which measurements are made (pp. 412-413); T, position of horny tip of upper jaw; *ca.b.* surface pits in cancellous bone; *f.* fenestration of interorbital septum; *f.r.* proximal limit of fusion of bony rami of lower jaw; *l.* lachrymal; *m.* margin of lower jaw; *o.p.* orbital process of quadrate; *r.p.* retro-articular process of lower jaw; *t.g.* tongue groove.

therefore soft and 'naked', but is underlain by bone in *Phoeniconaias* (cf. figures 1 and 5, and 20 and 23, plate 14).

The measurements (table 2) of adult specimens show considerable variation in bill size, but the data are inadequate to show if this is due to age or sex. Compared with *Ph. antiquorum*, the bills of *Ph'naias minor* are considerably shorter in total length, AT, and from bend to tip, BT; the height of both jaws together is less, though that of the lower alone is greater, owing to the arching upwards of the margin of the lower jaw at B'; this also makes the length of the gape, in proportion to the length of the bill, rather greater here. The

breadth of the lower jaw is almost the same in both species. Hume (1872, p. 32) is probably right in recognizing only a difference in sex between two species figured by Gray (1869, figure 3, plate XIII and figure 8, plate XV); the first, labelled *Ph'naias rubidus* Feild., he considers to be a female and the second, *Ph'naias minor*, a male.

TABLE 2. MEASUREMENTS OF THE BILLS OF *PHOENICONAIAS* AND *PHOENICOPARRUS*

The method of measurement in centimetres, corrected to 0.05 cm, is given on pp. 412–413, and the positions BN, B, etc., are shown for *Phoeniconaias* in figure 4a, and are comparable in *Phoenicoparrus* (figure 6a and b). *Ph'p. and.* = *Ph'parrus andinus* and *Ph'p. jam.* = *Ph'parrus jamesi*. Other symbols as in table 1.

species	<i>Ph'naias minor</i>						<i>Ph'p. and.</i>		<i>Ph'p. jam.</i>		
	R 792*	J 2	R 827	R 820	R 813	J 9	B 216	B 214	B 57	B 92	
specimen	...										
sex and age	...	m.	f.?	m.	f.	juv.f.?	juv.?	m.	f.	?	f.
<i>l</i> : AT	10.5	10.3	9.8	9.7	9.6	8.85	10.6	10.7	9.0	8.5	
BT	7.1	6.6	7.0	6.7	6.1	5.8	7.0	6.5	5.0	—	
<i>h</i> : upper at BN	0.65	0.65	0.4	0.4	0.6	0.4	0.95	0.35	0.4	0.4	
upper at B	0.2	0.2	0.2	0.2	0.2	0.1	0.2	0.1	0.1	0.1	
lower at BN'	3.2	2.95	3.05	2.8	2.65	2.5	3.5	3.5	3.0	3.15	
lower at B'	3.2	3.05	3.2	2.9	2.7	2.9	3.7	3.75	3.3	3.1	
total at BN	3.85	3.6	3.45	3.2	3.25	2.9	4.45	3.85	3.4	3.55	
total at B	3.4	3.25	3.4	3.1	2.9	3.0	3.9	3.85	3.4	3.5	
<i>b</i> : upper at BN	2.0	1.95	1.9	—	1.65	1.6	1.6	1.7	1.0	1.05	
upper at B	1.65	1.5	1.6	—	1.3	1.1	1.2	1.4	0.55	0.6	
upper at D	0.8	0.75	1.0	0.55	0.7	0.45	0.95	0.95	0.3	—	
upper at F	0.45	0.5	0.55	—	0.45	0.35	0.5	0.5	0.2	0.2	
lower at B'	2.8	2.55	2.7	2.45	2.2	2.5	3.05	3.2	2.3	2.4	
lower at D'	2.4	1.85	2.55	1.6	1.7	1.9	2.55	2.5	2.25	—	
'culmen' (PMJ)	11.7	11.5					12.0	12.1	10.1	9.6	
'culmen' for same species (Salvadori 1895)			10.2				11.7		8.6		
'length' (Rahmer 1887)							13.2		9.7		

\* Measurements of *Ph'naias minor*, Cr (AT=10.1 cm), R 809 (AT=10.3 cm), R 823 (AT=10.0 cm), J 7 and J 8 (AT=9.1 cm), are deposited at the British Museum (Natural History), London.

#### *The bill of Phoenicoparrus andinus*

The deep-keeled bill of this South American species (figure 6b) is closely comparable with that of *Ph'naias minor*. In fact the two species are so similar in bill structure that their allocation to different genera may well seem surprising.\* Only the lower jaw is here deeper and broader than that of *Ph'naias minor*, exceeding that of any other species of flamingo in girth, but not in length (cf. tables 1 and 2) although described as the 'largest and strongest' (Salvadori 1895, p. 22). The **deep keel**, the inflexed and **expanded borders** and the restricted tongue space are almost identical in both size and shape with those of *Phoeniconaias*. The walls of the lower jaw must therefore be considerably thicker.

The total length, AT, of the bills of the male and female specimens (table 2) is almost the same, but that of the male is distinctly longer from B to T and deeper at BN than that of the female (total *h* = 4.45 as compared with 3.85 cm).

\* The generic distinction seems to be based on the absence of a hind toe in *Phoenicoparrus*; but the hind toe appears always to be small in flamingoes, and is more reduced in *Ph'naias minor*, where its length is 1.2 cm and its width 0.12 cm or less, than in *Ph. antiquorum*, where it is 1.5 by 0.22 cm. The middle toe in the two latter species is about 8 cm long.

The first illustrated account of *Ph'parrus andinus* by Philippi (1860, p. 164, plates IV and V) refers only to external features; it is based on his earlier description, published both in Spanish and German, and translated into English by Cassin (1855, p. 200), who unfortunately confused the jaws, describing 'the inferior' as 'much narrower than the upper'. The facts had been correctly reported from the field by Philippi (1855, p. 11), who opined that *Ph'parrus andinus* would prove to be more like *Ph'naias minor* than like *Ph. chilensis*; but even in his later works (e.g. Philippi 1902, p. 74 and figure 3, plate XXXIII, and plate XXXIV) he did not mention the internal form of the bill, which fully supports his

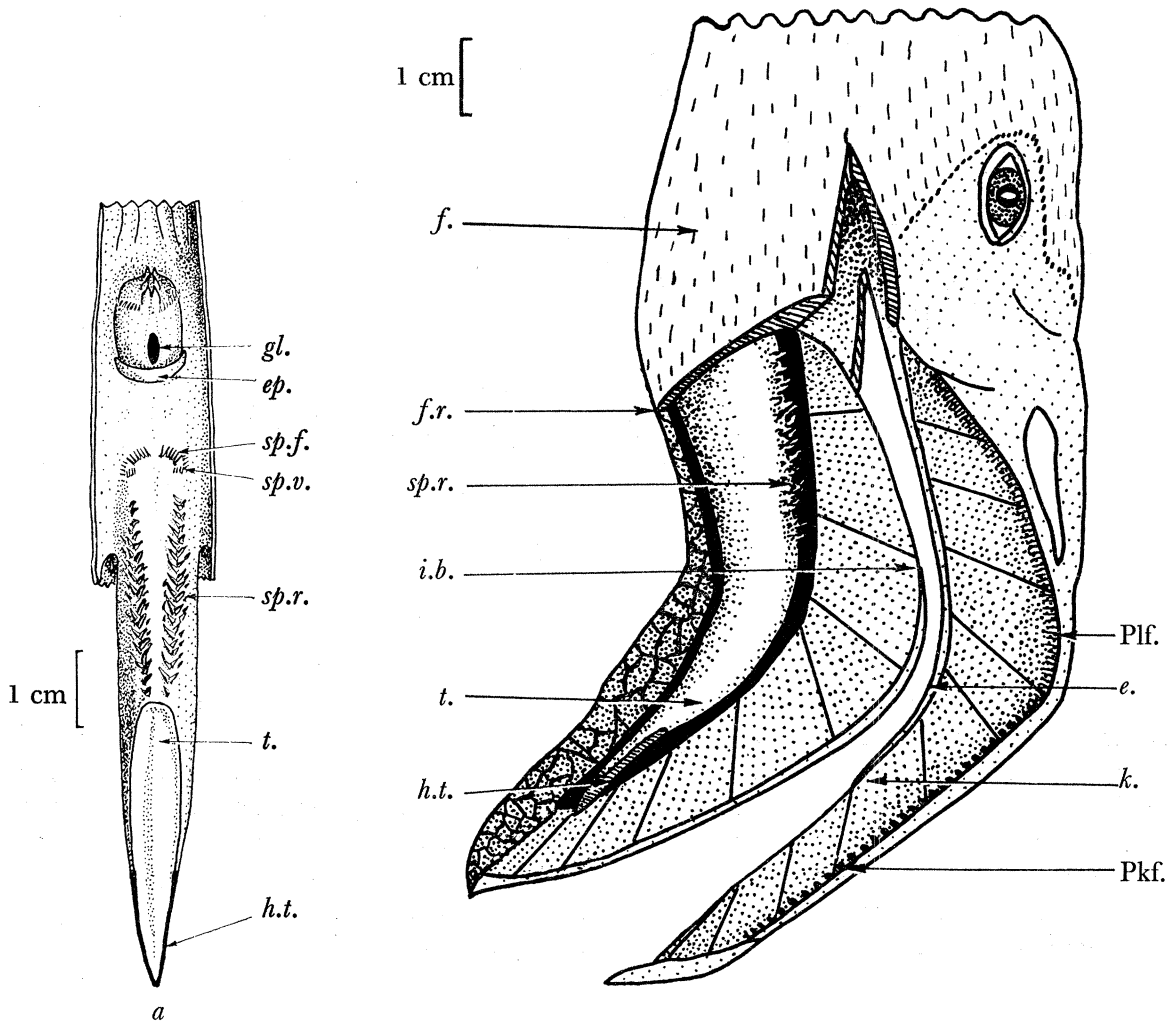

FIGURE 5. Head of *Ph'naias minor* (J2) with part of the lower jaw cut away to expose the tongue, *t.*, in the narrow tongue groove. The bill is opened widely to show the deep keel, *k.*; this position might be adopted when calling, but not when feeding. The lines on the lamellated areas on both jaws indicate the direction of the diagonal rows, formed by the alinement of the filter-forming platelets in adjacent lamellae. (a) Upper surface of the tongue of *Ph'naias minor*, shown on the same scale as figure 1 a. *e.* free edge of keel without lamellae; *f.r.* proximal limit of bony fusion of rami of lower jaw, meeting front edge of feathers, *f.*, ventrally; *i.b.* expanded, inflexed border, with indicator arrow crossing to its lateral margin; Pkf, fringed marginal hooks forming 'excluder' when the bill is closed; Plf, fringed marginal leaflets, forming proximal part of excluder; *sp.r.* recurved and subdivided spines on the tongue (cf. figures 17 b and c). Other letters as in figure 1.

view. There is a good coloured plate of the whole bird, but no detail of the bill, in Goodall, Johnson & Philippi (1951, p. 113, plate XVIII). Otherwise there has been much confusion between this species and the following.

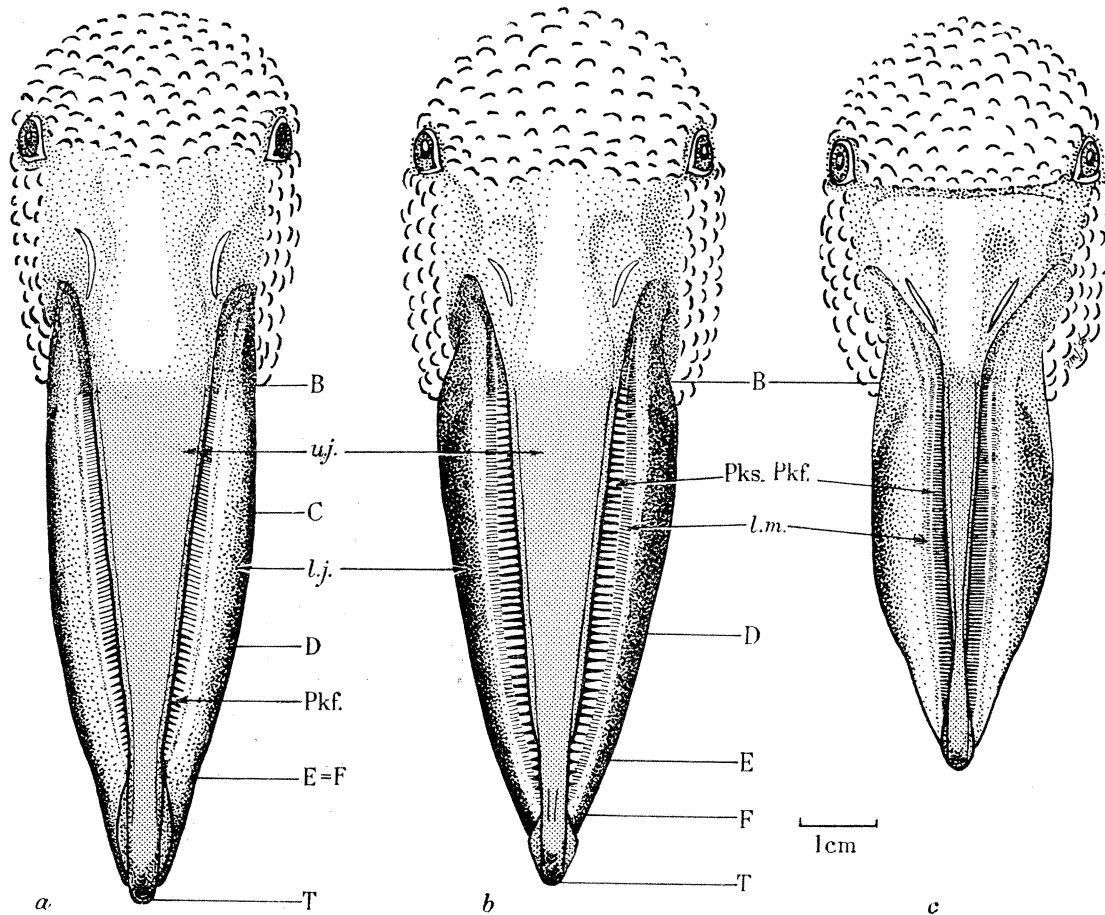

FIGURE 6. Front view of heads of deep-keeled species, to show the relative shapes and sizes of the upper and lower jaws, particularly from the bend, B, to the tip, T, for comparison with figure 3. The upper jaw, *u.j.*, is always narrow in relation to the lower, *l.j.*, and is sunk between the rami of the latter. The outer lamellae, Pkf and Pks, project sideways to form the excluders, and are always visible in this view of these species. Positions B to T as in figure 4*a*. (*a*) *Ph'naias minor*, adult male, R 792. (*b*) *Ph'parrus andinus*, adult female, B 214. The marginal platelets, *l.m.*, on the lower jaw are visible here and in figure 6*c*. (*c*) *Ph'parrus jamesi*, adult specimen of unknown sex, B 57.

#### *The bill of Phoenicoparrus jamesi*

The bill is at least 1.5 cm shorter from B to T than that of any other species; the lower jaw, which is scarcely narrower than that of *Ph'naias minor* at B' and D', tapers sharply towards the tip, T (cf. figures 6*a* and *c*). The most remarkable feature of the bill of *Ph'parrus jamesi* is the extreme narrowness of the upper jaw, which is almost a case of *reductio ad absurdum*! From a point, AN, above the nostrils, where it is 2.3 to 2.4 cm wide, like *Ph'naias minor*, it tapers rapidly to 0.55 cm at B, where it is already less than half the width of any other species. Beyond B it tapers still farther to a minimum of 0.2 cm at F, just above the tip. Thence its hard horny shield expands again to 0.4 cm, before coming to the usual blunt end (table 2). The outer lamellae cross the gape horizontally, as before.



It was not possible to open the bill of the two available specimens of this rare species at all widely, for fear of damaging them; but enough could be seen to make it clear that the internal form has the same plan as in *Ph'parrus andinus* and *Ph'naias minor*. The sides of the **keel** on the upper jaw and the **inflexed borders** of the lower jaw are again flat and have the same orientation as in the other two species; but, because the narrow upper jaw still retains the form of an equilateral triangle in section, the keel is not nearly so deep as in the two previous species, and the inflexed borders of the lower jaw are correspondingly narrow.

Figures by Gray (1869, figures 9 and 10, plate XV) show a clear and accurate profile and full face of this species, but they are labelled *Ph'parrus andinus*, the two species not having been separated at that time (cf. Salvadori 1895, p. 22). The distinction was made by Sclater (1886, p. 399 and figure 3) and by Rahmer (1886, p. 754). The latter account was translated and illustrated the next year (Rahmer 1887, pp. 160 to 162, figure 1, plate II), but his drawings do not make sufficient difference between the width of the upper jaw in this species and in *Ph'parrus andinus* (Rahmer 1887, figure 3). No account gives any indication of the internal structure of the bill of either species of *Phoenicoparrus*.

#### 6. STRUCTURE, SIZE AND VARIATION OF THE LAMELLAE

When the bills of flamingoes are examined, even superficially, the regularly spaced horny lamellae with which they are lined immediately strike the eye, and their use as filters has been duly deduced by many writers. Slight magnification shows the lamellae to be much coarser and less closely set in the shallow-keeled bills of *Phoenicopterus*, as shown in plate 17, than in the deep-keeled bills of the group including *Ph'naias minor*, shown magnified to the same extent in plates 15 and 16. This accords with the larger size of food taken by the former species and smaller food by the latter. A drawing such as figure 14*a* shows that in *Ph'naias minor* the fringed platelets formed from the lamellae have spaces between the fibres of the fringe of apparently the right size to catch the diatoms and algae of its food (figures 14*c* and *d*). It has proved more difficult to put these facts on a quantitative basis and to identify by measurements the structures used as filters and excluders in the different species. Yet without measurements the evidence remains inconclusive. The problem is complicated by the fact that, apart from specific differences, there is much qualitative variation in form and degree of subdivision of the lamellae in different parts of the lamellated areas in each species; and for many of these variations, beautiful as they are to the human eye, no clear function is apparent. But from the following study of the variations in form, size and arrangement of the lamellae in the six species, it is now possible to say which spaces can be used to catch the given range of particle size, which the flamingo in question ingests, and which spaces can exclude particles of greater size, which are not collected. It is also necessary to determine whether the spaces, when found, are orientated in such a way that the water currents set up in the bill are likely to pass through them. Very little previous work has been found to be of use for this purpose; references to the filtering functions of the outer lamellae are much too generalized and the inner lamellae have, until recently (Ridley 1954, p. 6), been passed over with scarcely a word; and this despite the emphasis laid by Poncy (1926, p. 17) on the undoubted interest that would be derived from a careful study of the inside of the bill of these birds. Perhaps even he did not foresee the astonishing degree of complexity which would be revealed.

The lamellae are thickenings of the horny lining of the bill, and can be seen on careful examination to conform to certain general morphological characters throughout the six species, despite differences in detail. They are formed by the epithelium covering the lamellated areas described above (§ 5), and are strips of relatively tough but flexible horn projecting through a softer matrix. This seems also to be a form of horn or keratin; but it is practically structureless when examined by polarized light, whereas the lamellae are always fibrous. The smaller lamellae appear to be solid, but the larger are shells filled with non-fibrous material. All lamellae tend to darken with age, from pale yellow, through brown, to black, presumably by tanning of their proteins.

The lamellae run transversely across the lamellated areas towards the tongue, or slant slightly towards the bend of the bill. Plate (1922, p. 262 and figure 235 F) subdivides them conveniently, in his account of *Ph. roseus*, into 'outer' and 'inner' lamellae, respectively occupying the outer and inner parts of the lamellated area. These are often distinct in form and size, though they may be continuous with one another and even be virtually indistinguishable, except by their position. The distinction between them is most noticeable on the distal part of the upper jaw, where some of the outer lamellae form large hook-like 'marginal' platelets, while the corresponding inner lamellae may be more than five times as numerous and only a quarter the height.

#### *Types of lamellae*

Variations in the lamellae can be described as belonging to one or more of the following three types, probably representing stages in their evolution:

(i) *A smooth ridge*, type R, formed from the whole, or a large part, of a lamella and varying only slightly in the height to which it projects above the matrix. This type (figure 7*a*) is the simplest structurally and may well be primitive, since it also occurs in other genera of 'Lamellirostres' (e.g. *Anas*, etc.) in both inner and outer lamellae. In flamingoes it is confined to the inner series.

(ii) *A serrated ridge*, type S, similar to the foregoing, but with the free edge more or less deeply serrated (figure 7*b*). This appears to be an intermediate type, and occurs in both inner and outer lamellae.

(iii) *A series of platelets*, type P, formed apparently by the serrations of the second type becoming so deep that the ridge joining the peaks fails to develop, and the peaks are left as isolated processes. The large hook-like marginals (type Pk, figure 7*f* and *h*) and the leaf-like marginals (type Pl, figure 7*e* and *g*) and the intermediate submarginals *s.m.*, figure 7*f* and *h*), formed from the outer lamellae of the upper jaws, may all be regarded as enlarged platelets.

A further distinction must be made in all three types between those lamellae or platelets with smooth edges, *s.*, (e.g. Rs and Ps, figure 7*a* and *c*) and those with the free edge fringed, *f.*, (e.g. Pf, figure 7*d*).

Table 3 shows the general distribution of these types in the bills of the six species of flamingoes. Where a lamella does not have the same form throughout its length, but has, say, smooth platelets at its outer end giving place to a smooth ridge nearer the tongue, this is indicated by the compound sign, Ps/Rs. Where there is no distinction in form between the outer and inner lamellae these are bracketed together; continuity of form along the length of the bill is shown by a line joining the symbols indicating the type.

The regularity of the lamellae and their variants, which make such a system of description possible, is shown in plates 15 to 17. Nevertheless, the regularity is not perfect, and some lamellae may be slightly curved instead of straight, some may branch, and many may stop short, instead of crossing the whole width of the lamellated area.

When the lamellae are subdivided into platelets an appearance of **diagonal rows** is produced; but careful inspection makes it clear that this is not due to a reorientation of the

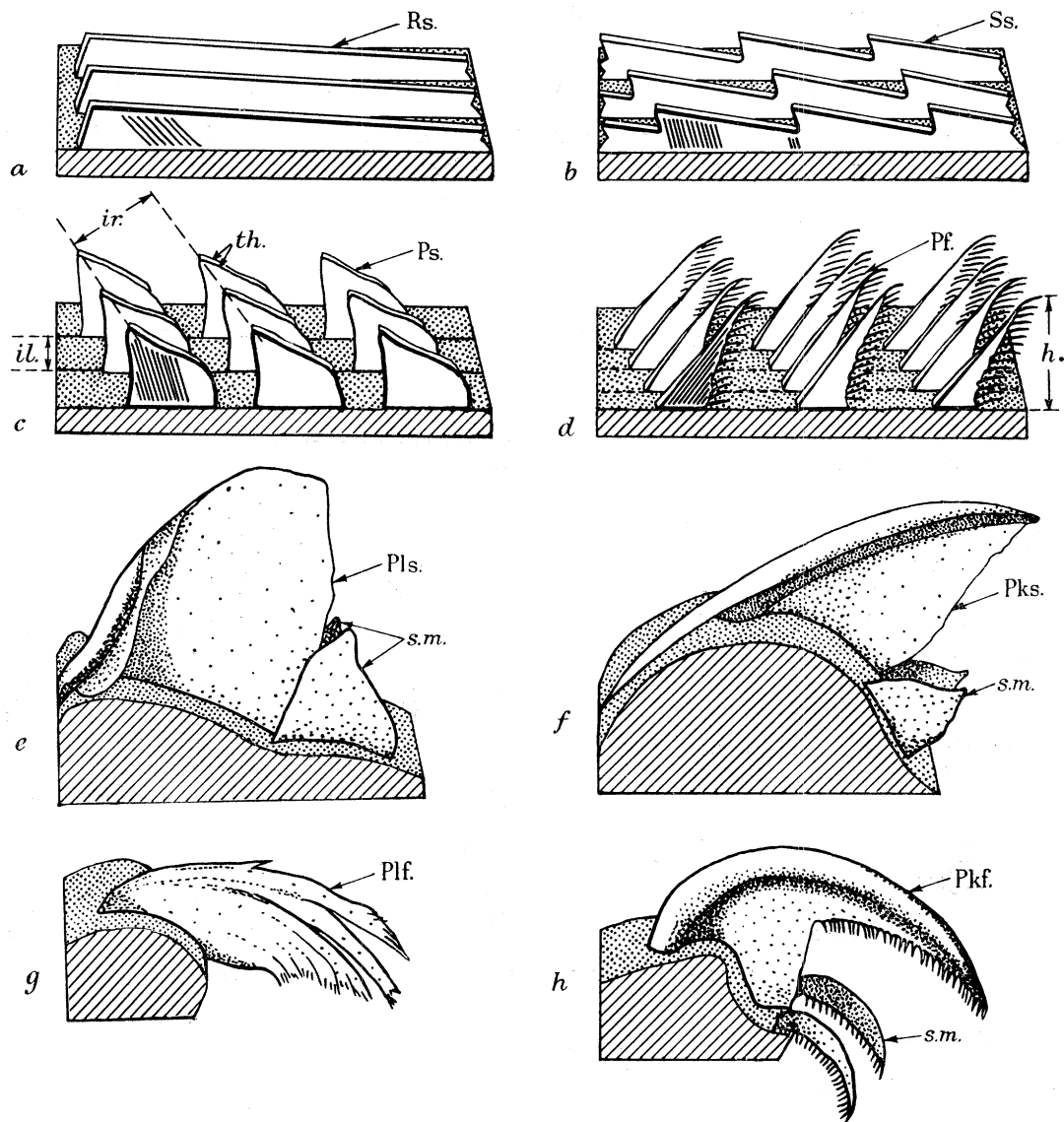

FIGURE 7. Diagram showing different types of horny lamellae, seen in perspective on isolated pieces of skin from the lining of the bill. Their occurrence is shown in table 3, and figures 8 and 11. (a) to (d). *Inner lamellae* or their derivatives, all orientated as if the gape were to the left. The slanting lines on the lamellae, but not the shading on the matrix, indicate the direction of fibres in the horn, as revealed by their birefringence. (a) Smooth ridges, Rs. (b) Serrated ridges, Ss. (c) Smooth platelets, Ps, formed by breaking up of ridges. *il.* distance between lamellae; *ir.* distance between diagonal rows; *th.* thickness of platelet, which is measured close to the matrix. (d) Fringed platelets, Pf; *h.* vertical height of platelet. (e) to (h). *Outer lamellae*, on smaller scale than (a) to (d). (e) Smooth marginal leaflet, Pls, with smaller submarginals, *s.m.* (f) Smooth marginal hook, Pks, with submarginals, *s.m.* (g) Fringed marginal leaflet, Plf. (h) Fringed marginal hook, Pkf, with submarginals, *s.m.*

original lamellae, as might be supposed, but to a secondary diagonal alinement of the platelets in adjacent lamellae. Several facts point to this conclusion. The long axis of the base of the platelets themselves is usually transverse to the bill, like that of the serrated lamellae, and rarely, if ever, in line with the diagonal row. In an old specimen, pigment joins the bases of platelets in the same lamella, but not in the same row, and if part of the lamella remains as a ridge, instead of being broken up into platelets (as in type Ps/Rs), then the ridge also follows the transverse lamellar line, and not the diagonal row.

TABLE 3. DISTRIBUTION OF TYPES OF LAMELLAE IN DIFFERENT REGIONS OF THE BILL

R=ridge, S=serrated ridge, P=platelet, s=smooth, f=fringed, l=leaf-like, k=hooked. Ps/Rs, etc., indicate a change in form from lateral to median ends of a lamella.

position on the bill (pp. 412-413)	Z-AN	AN-BN	BN-B	B-C	C-F		
shallow-keeled bills							
<i>Phoenicopterus</i> species							
upper jaw							
outer lamellae: marginal	Pls	_____	Pls	Pks	_____	Pks	
outer lamellae: submarginal	Ps	_____	_____	_____	_____	Ps	
inner lamellae	Rs	Ps/Rs	Ps	_____	_____	Ps	
lower jaw							
outer lamellae	Ss	_____	_____	_____	_____	Ss	
inner lamellae	Rs	Rs/Ss/Rs	Ss	Rs/Ss/Rs	Rs		
deep-keeled bills							
<i>Ph'parrus andinus</i>							
upper jaw							
outer lamellae: marginal	?	Pls	_____	Pls	Pks	_____	Pks
outer lamellae: submarginal	?	Ps	_____	_____	_____	Ps	
inner lamellae	?	Ps	_____	_____	_____	Ps	
lower jaw							
outer lamellae	?	{ Ps	_____	_____	_____	Ps } *	
inner lamellae	?	{ Ps	_____	_____	_____	Ps }	
<i>Ph'naias minor</i> and <i>Ph'parrus jamesi</i>							
upper jaw							
outer lamellae: marginal	Plf	_____	Plf	Pkf	_____	Pkf	
outer lamellae: submarginal	Pf	_____	_____	_____	_____	Pf	
inner lamellae	Pf/Rf	Pf/Rf	Pf	_____	_____	Pf	
lower jaw							
outer lamellae	{ Pf	_____	_____	_____	_____	Pf } *	
inner lamellae	{ Pf/Rf	Pf/Rf	Pf	_____	_____	Pf }	

\* Bracketed inner and outer platelets are indistinguishable in form.

Polarized light shows that most of the fibres in the lamellae and platelets lie in a plane passing through the long axis of the original lamella and vertical to the bill epithelium. The fibres within this plane are inclined at an angle passing upwards from the underlying bill surface. In the smooth ridges (Rs) the angle with the surface is small; in the serrated ridges (Ss) the angle may be somewhat increased to run upwards and outwards, away from the tongue, into the peaks between the serrations. The same is true of the low platelets (Ps) of *Ph. antiquorum*. In the tall, narrow platelets (Pf) of *Ph'naias minor* the fibres run through the matrix and directly up the length of the platelet to its free edge, and then curl over towards the tongue. They therefore slope the opposite way from the fibres in the ridges (figure 7a to d). This change in orientation of the fibres accompanies, and perhaps accounts for, the change in orientation of the tips of the platelets, to be seen in comparable photographs of the two species. In *Ph. antiquorum* (figures 30 and 31, plate 17) the tips of

the inner platelets point outwards towards the margin; and in *Ph'naias minor* (figures 26 and 27, plate 15) they point inwards towards the tongue.

This orientation of the fibres in *Ph'naias minor* also suggests a way in which the fringe is formed along the edge of each platelet, nearest to the tongue. If the fibres were slightly asymmetrical, like curly hair, and were only kept straight within the body of the platelet by being in some way cemented together, then, as this cement wore off and the fibres were released, they would begin to curl to form the fringe (figure 14*a*).

*Measurement of lamellae*

There is no simple method of measuring the mesh of filters formed by the lamellae, nor does the material lend itself to extreme accuracy of measurement, since it shows frequent small irregularities. The following measurements, expressed in millimetres, are used in both the text and tables:

*A*, the **area** covered by lamellae is computed by cutting out the shape of one side, of both the upper and the lower lamellated areas, in squared paper, and counting the squares. The total lamellated area is given as twice the sum of these two; but a filter formed of inner lamellae may only be effective when upper and lower lamellae are more or less in contact, the efficiency of the filter being proportional to the area of the upper or the lower lamellae, but not both.

*lA*, the **length** of the area along its outer margin from T to Z (pp. 412-413).

*bAi* and *bAo*, the **breadth** of that part of the area carrying **inner** and **outer** lamellae respectively; *bAi* + *bAo* = total length of the lamellae themselves, where these are transverse to the long axis of the jaw.

*th*, the **thickness** of an individual lamella is measured where it projects through the matrix, unless otherwise stated (figure 7*c*).

*h*, the **height** of a lamella or platelet is measured vertically above the matrix, and not along the longest axis of the platelet, if this is inclined to the vertical as is usual (figure 7*d*).

*il*, the **inter-lamellar distance** is the shortest distance from the middle of one lamella to that of the next (figure 7*c*). Sometimes the mean of about ten adjacent spaces has been taken. The open space between the lamellae is taken to be *il*-*th*.

*ir*, the **inter-row distance**, or the distance between the diagonal rows formed only by lamellae subdivided by serrations (S) or into platelets (P), is the shortest distance between the peaks in adjacent rows. The size and shape of the open space between these rows depends on the shape of the platelets and the angle at which they are set.

*lp*, the **length** of the base of the platelet.

Many of these measurements vary along the length of the bill, as is shown in the tables by giving measurements at AN, BN, etc. (§ 5 and figures 1 and 4*a*).

The main variations in the form of the lamellae in different parts of the bill are summarized in table 3, and shown diagrammatically in figures 7, 8*a* and *b* and 11. Details of their variation in form and size are described below in the same order for each species, starting with the inner lamellae of the lower jaw, which are the least specialized in *Phoenicopterus*, and ending with the outer lamellae of the upper jaw, which are the largest and most specialized in all species. The measurements are summarized in tables 4 to 9.

6.1. *Lamellae of flamingoes with shallow-keeled bills**The lamellae of Phoenicopterus antiquorum*

The description of the lamellae is based mainly on an adult specimen (J3, tables 4 and 5) and partly on a young specimen (J4, table 6). Four specimens, Ca to Cd (p. 408), have been measured less fully; Cd was slightly larger than J3, but the others were smaller and fell between this and J4; J3 and J4 may therefore be taken to show the normal size range for this species.

The **lamellated areas** (p. 414) carry all the lamellae and are 125 mm long from the bill tips, T and T', to Z and Z', 20 mm proximal to the nostril (figures 1 and 2). The area is bluntly truncated proximally and tapers towards the tip, from the point C' on

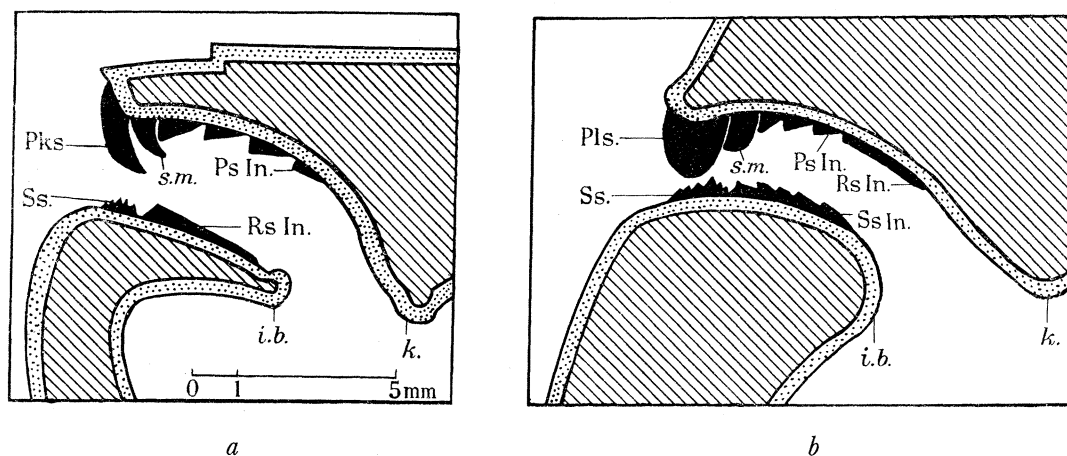

FIGURE 8. Diagrammatic transverse section of parts of the bill of *Ph. antiquorum* to show the distribution of different types of lamellae (solid black) lining the gape. (a) at D, distal to the bend (figure 1). (b) at BN, proximal to the bend. The types of outer lamellae are indicated by the same letters as in table 3 and figure 7. The types of inner lamellae are indicated in the same way, with the addition of In; thus inner lamellae forming smooth ridges, as on the keel, are Rs In. *i.b.* inflexed border on the lower jaw (the pointer line marks the median edge, Ss the lateral edge); *k.* keel on the upper jaw; *s.m.* submarginals.

the lower jaw and from D on the upper. Inner and outer lamellae are distinguishable throughout the length on both jaws. The breadth of most of the area occupied by inner lamellae (*bAi*, table 4) is 4.5 mm on the upper jaw and 3.5 mm on the lower. The breadth of the area occupied by the outer lamellae (*bAo*, table 5) is 1.5 mm on the upper jaw and 1.2 mm on the lower, tapering only at the extreme ends in both cases. The total area (*A*, p. 425) of inner lamellae in this bill is about 19 cm<sup>2</sup>.

The **inner lamellae of the lower jaw** nearly all cross the inner part of the lamellated area transversely, or slant very slightly backwards towards the throat as they pass inwards. On the horny tip of the bill they swing round to run directly backwards, so that they meet at the midline, parallel with those of the other side of the bill, and form a fan, leaving only 3 mm of smooth concave horn on the inner face of the extreme tip.

Simple low ridges with a smooth edge (Rs, figures 7a and 8a and 32, plate 17) occupy the fan at the tip of the bill, and also the whole area from F' to C'. Thence serrations appear near the middle of the lamellae and gradually spread until, between B' and BN',

the whole length of each lamella is deeply serrated (Ss, figure 7*b*) and may be almost divided into platelets. Proximal to BN' (Rs/Ss/Rs, figure 33, plate 17), the serrations disappear again progressively until the whole of each lamella reverts to a smooth ridge (Rs). The detail of this pattern seems to differ with age, since the distribution varies, and the notches are not so deep in the juvenile specimen. The peaks are all sharply pointed and directed towards the outer edge of the bill. They also show some diagonal alinement, comparable to that of the platelets on the upper jaw. Over much of the lamellated area each lamella is tilted, as a whole, somewhat backwards towards the throat.

The size of the lamellae varies little throughout the area, despite the changes in form of their free edges. The **thickness** (*th*) is everywhere about 0.03 mm and the **height** (*h*) is almost constant at 0.2 mm at the lateral edge of the area, but may decrease towards the median edge. The **spacing** of the lamellae (*il*) is usually just under 0.2 mm (table 4), but decreases slowly from the tip of the bill to the base.

The **inner lamellae of the upper jaw** of *Ph. antiquorum* are, by comparison with the foregoing, larger and less varied in form. They are nearly all divided into smooth unequal triangular platelets (Ps, figures 7*c*, 8*a* and *b* and 30 and 31, plate 17), with their free points directed **outwards**, like the peaks on the lower jaw. Also like these, the platelets have become alined throughout in diagonal rows, producing the pattern which first strikes the naked eye; but magnification shows that from F to B the original lamellae, indicated by the long axes of the platelets, are again almost transverse to the margin, like those on the lower jaw. Between BN and AN they gradually diverge from this direction, to slant considerably forwards as they pass in. This can be seen particularly well in the smooth ridges, formed by lack of complete subdivision of the lamellae, in this part of the area (Ps/Rs, figure 31, plate 17). Under the horny tip of the bill the inner lamellae swing round to run straight backwards, as they do on the lower jaw; but here the lamellae nearest the mid-line are smooth ridges, while the rest form small platelets, still directed 'outwards', which is in fact forwards. They leave only 0.5 mm of smooth horn round the extreme front edge, T.

The **thickness** (*th*, 0.03 to 0.06 mm) of the platelets is usually greater than that of the lamellae on the lower jaw; that of a few platelets, near the median edge of the area, may swell to about 0.16 mm, thereby compensating to some extent for the greater spaces between them (figure 30, plate 17). The **height** (*h*, 0.2 mm or more) at the median edge is about the same as that of lamellae on the lower jaw, but increases towards the lateral edge, where it reaches about 0.4 mm nearly all along the bill. Those next to the submarginals distally may be about 0.6 mm in height, like the left-hand pair in figure 10*a*. The **spacing** of the lamellae (*il*) again decreases from F (0.25 mm) to Z (0.13 mm), and is about the same (within the limits of regularity of the structures and the methods of measurement) as at the corresponding points along the lower jaw (table 4).

The production of the **diagonal rows** on the upper jaw is achieved by the slanting alinement of inner platelets in adjacent lamellae. The platelet in each more proximal lamella is a 'step' nearer the median edge than its distal neighbour. The size of the 'step' is not always the same, nor is the length (*lp*) of the base of the platelets; but both increase towards the median edge in a fairly regular way. This results in the rows becoming broader and more widely spaced (shown as increases in *ir* in table 4). By plotting the distribution of

individual platelets over a small area on an enlarged scale, it becomes apparent that in some lamellae (*l'*, figure 9) the platelets must stop short of the median edge of the lamellated area. Their successive neighbours approach the edge more nearly, until the terminal platelet of a diagonal row is placed at the extreme median edge (*med.*) of the area. The next more proximal lamella will again be very short. Similarly the lamellae end at varying distances from the lateral edge (*l.*, figure 9); but the pattern there is relatively obscure as the distances are less and alternate platelets are 'missing' (open rings), chiefly between the submarginals. Most diagonal rows end in 3 to 5 submarginals (*s.m.*) and an overhanging marginal platelet (Pks, see p. 430 below). There are periodical extra rows which end, as it were, blindly (*e.r.*, figures 9 and 30, plate 17) without a terminal outer lamella. Proximally (figure 31, plate 17) there are more marginal lamellae than diagonal rows.

TABLE 4. INNER LAMELLAE OF *PHOENICOPTERUS ANTIQUORUM*

Measurements of the inner lamellae of an adult specimen (J3) in millimetres, corrected to 0.03 mm. Types of lamellae as in table 3. The dimensions are shown on the left as *bAi*=the breadth of the lamellated area, carrying inner lamellae, *h*=the height of the lamellae, *th*=the thickness of the lamellae, *il-th*=the space between one lamella and the next, and *ir*=the distance between the tips of the platelets in adjacent diagonal rows, where these occur (p. 425). Gradients across the lamellated area are shown by dimensions for the lateral and median edges. Gradients along the jaws are shown by dimensions at AN, BN, etc. (figure 1).

position ...	upper jaw				lower jaw			
	AN	B	C-D	E-F	AN'	B'	C'-D'	E'-F'
type ...	Ps/Rs	Ps	Ps	Ps	Ss	Rs/Ss/Rs	Rs	Rs
<i>bAi</i>	4.5	4.5	4.5	4 to 2	3.5	4.0	3.5	3 to 2
<i>h</i> : lateral	0.36	0.43	0.4	0.4	0.2	0.2	0.2	0.2
median	0.2	0.26	0.23	0.16	0.23	0.1	0.2	0.16
<i>th</i> : lateral	0.03	0.03	0.06	0.02	0.03	0.03	0.03	0.03
median	0.06	0.03	0.16	0.1	0.03	0.03	0.03	0.03
<i>il-th</i> : lateral	0.1	0.16	0.16	0.23	0.1	0.13	0.16	0.2
median	0.1	0.16	0.03	0.2	0.1	0.13	0.16	0.2
<i>ir</i> : lateral	0.4	0.4	0.4	0.26	0.23	0.43	—	—
median	—	0.56	0.7	0.26	—	—	—	—

The **outer lamellae of the lower jaw** are all serrated (Ss, figure 8*b*), but more deeply near the base of the bill. Their **thickness** (*th*) is much greater than that of the inner lamellae, and gives them a blunt and almost inflated appearance, especially near the tip of the bill. Their **height** (*h*) is usually greatest at the median end and tapers down outwards (figure 8*a* and *b*). At D' (figure 10*b*) they reach a maximum height of 0.8 mm, four times that of the adjacent inner lamellae; proximally their height decreases until at AN' it equals that of the inner lamellae (table 5). Their **spacing** (*il*) is considerably wider than that of the inner, and varies more along the length of the bill, from 0.73 mm at D' to 0.26 mm at AN'. The change in spacing is not proportional to that of the inner series, with the result that distally, from B' to F', each outer is continuous with one inner lamella, and usually has from one to three more inner lamellae between it and the next outer; but this is reduced to one or none proximally (figures 32 and 33, plate 17). The total number of outer lamellae in the adult is close to 260, not 350 as estimated by Poncy (1926, p. 16).

Each of the **outer lamellae of the upper jaw** of *Ph. antiquorum* forms one, or at most two, separate platelets.



The **submarginal platelets** (*s.m.*, figure 8*a* and *b*) are the most numerous; they are formed from part or all of each outer lamella, in a position within the extreme edge of the jaw; they partly overlap the marginals and are carried on the same longitudinal ridge. They are smooth and triangular, with the apex to the inner side, like that of the marginals and unlike the inner platelets (*s.m.*, figure 30, plate 17). They are larger than the adjacent inner platelets, except near the base of the bill, from AN to Z. The largest, between C and B, reach 0.06 mm in **thickness** and 1.0 mm in **height**; they decrease proximally, and to

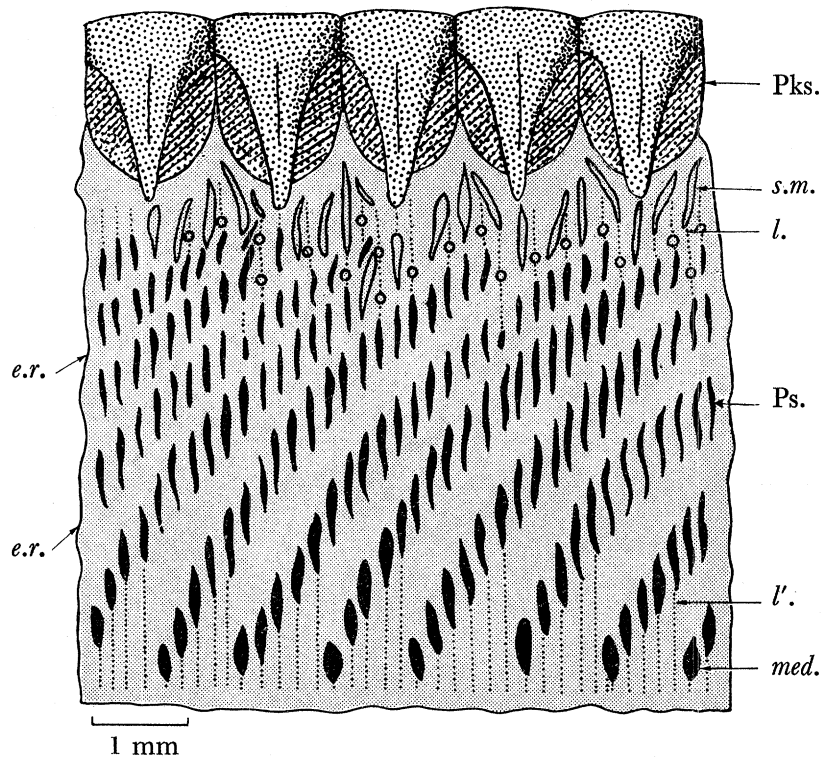

FIGURE 9. *Ph. antiquorum*. Diagram of a surface view of part of the lamellated area near D on the upper jaw, similar to that photographed in figure 30, plate 17, where the lateral margin of the bill, carrying the large marginal hooks, Pks, is on the left instead of at the top. In the middle of the area the transverse lamellae (vertical in the diagram) are regularly represented by smooth platelets, Ps (solid black), diagonally aligned. At the median edge, *med.*, the lamellae, *l'*, stop short (dotted lines). At the outer edge of the area, submarginals, *s.m.* (outline), occur rather irregularly at, or near, the end of every other lamella. The positions of missing platelets at the lateral edge (open rings) are connected by dots to the next space, or platelet, in the same transverse lamella, *l*. Marginal hooks, Pks (heavy dots), occur regularly at the extreme other end of every seventh lamella. Two extra diagonal rows, *e.r.*, can be seen to have neither submarginals nor marginal hooks related to them. The tip of the bill would be to the right.

a lesser extent distally, from this point. Their **spacing** is irregular, especially distally, where three or more may converge in the space between two of the marginal hooks; nevertheless, one submarginal always corresponds with each alternate inner lamella, even when a marginal is also formed from the same outer lamella. A group of about four stand at the end of each of the main diagonal rows of inner platelets, between these and the marginals. Submarginals are absent from the extra diagonal rows (*e.r.*, figure 9). Previously these submarginals seem either to have been overlooked or to have been

included with the inner lamellae, though it seems clear that they represent outer lamellae. Viewed from inside the bill (figure 30, plate 17) they are much obscured by the marginals curling inwards over them, but careful inspection from outside reveals them projecting downwards part way across the gape and converging to reduce the size of the spaces between the marginals.

The **marginal platelets** formed from outer lamellae of the upper jaw are the best known of the flamingo's lamellae, as they are visible externally (e.g. Hesse & Doflein 1914, p. 241\* and Abb. 193); they are the largest and most specialized lamellae in this species and form the main part of the filter. They become deeply pigmented with age, and

TABLE 5. OUTER LAMELLAE OF *PHOENICOPTERUS ANTIQUORUM*

Measurements of the outer lamellae of an adult specimen (J3) in millimetres, corrected to 0.03 mm. *bAo* = breadth of area occupied by outer lamellae; other symbols and explanations as in tables 3 and 4.

position ...	upper jaw				lower jaw			
	AN	B	D	F	AN'	B'	D'	F'
type: marginal ...	Pls	Pls	Pks	Pks	Ss			Ss
submarginal ...	Ps			Ps	Ss			Ss
<i>bAo</i>	1.5	1.5	1.46	1 to 0	1.2	1.2	1.2	1 to 0
<i>h</i> : marginal	0.73	1.9	1.5	2.2	0.2	0.5	0.8	0.5
submarginal	0.33	1.0	0.8	0.43	—	—	—	—
<i>th</i> *: marginal maximum	0.13	0.33	0.53†	0.33	0.06	0.16	0.23	—
marginal minimum	0.06	0.1	0.06	0.06	—	—	—	—
submarginal	0.03	0.06	0.02	0.02	—	—	—	—
<i>il</i> : marginal	0.53	0.86	1.5‡	1.1	0.26	0.63	0.73	0.63
<i>il-th</i> : marginal minimum	0.4	0.53	0.96	0.76	0.2	0.46	0.5	ca. 0.4
marginal maximum	0.46	0.76	1.43	1.03	—	—	—	—
<i>il</i> : submarginal	0.26	0.26	0.43	0.4	—	—	—	—
<i>il-th</i> : submarginal	0.23	0.2	0.41	0.38	—	—	—	—

\* Recorded as measured, but not as accurate as other dimensions; minimum taken at tip of platelets.

† Maximum at position C=0.63 mm.

‡ Maximum in specimen Cd=1.76 mm.

are the 'Black Teeth, . . . slender, numerous and parallel, as in Ivory Combs; but also very short, scarce the eighth of an inch deep' of Grew (1681, p. 68). Though none is continuous with an inner lamella, each retains its relation with one in every five or six of them. They show the original transverse lamellar orientation, except at F, where they slant markedly backwards and inwards. The length of their bases is 1.5 mm (*bAo*, table 5). Between F and B the marginals are hook-like in form (Pks, figures 7*f* and 8*a*, and 30, plate 17), and are sharp and inflexible. They resemble rose thorns, with the tapering hollow spine on their outer edge curling inwards over the attached inner 'blade', which is slightly concave proximally. From B to the base of the bill there is a graded series of leaf-like marginals (Pls, figures 7*e* and 8*b*, and 31, plate 17) in which the spine becomes progressively shorter proximally. Between B and BN the blade is not shortened, but projects freely at the tip to a greater extent as the spine gets shorter; from BN to Z the blades also become shorter. The proximal concavity of these thin leaflets increases towards AN, and their free outer edge may so curl round towards the base of the bill, as to simulate in external view the surface of a solid spine. It is, in fact, no more solid than the rest of the blade, but it probably reduces the passage between the marginals as effectively as the solid spines do.

\* By a slip these authors refer to large marginal lamellae on the *lower* jaw, although they figure them correctly.

In the juvenile, that is otherwise so similar to the adult, the marginal hooks only extend to C instead of B before giving place to leaflets. Having more of the close-set leaflets, the total number of marginals in the juvenile is 200, instead of 150 in the adult; incidentally, this raises the curious but as yet unanswered problem of how they may grow or be replaced.

The **thickness** (*th*) of the blade of either form is only about 0.06 mm, which is little more than that of the adjacent submarginals; but the leaflets must be stiffened by their curved shape and by what spine they may have. The thickness of the spines of the hooks appears to be fairly uniform from F to B and of a different order of magnitude (0.53 mm) from all the other lamellar structures described. The size of all the marginal hooks from F to B is closely similar; but their vertical **height** (*h*), particularly round D and C, is much reduced because they curl inwards instead of hanging down vertically. Their **spacing** (*il*) is very wide compared with that of any other lamellae. From F to C, *il*=1.5 mm; it decreases, with the change from hooks to leaflets, to 0.86 mm at B, and thence more slowly to 0.53 mm at AN. This wide spacing of the distal marginals allows of three submarginals and up to six inner lamellae (*il*, 0.2 mm) being present between them. It also follows that, when the bill is closed, there will be at least two outer lamellae on the lower jaw (*il*, 0.73 mm) to every marginal on the upper.

In the specimen *Cd* (§ 4), the maximum measurement for *il* is 1.76 mm, considerably greater than in J3 (table 5). This difference is interesting, as the total lengths of the two bills are not very different (table 1); other evidence, though slight, points to both specimens being female. There are at present insufficient data to show what effect age may have upon the spacing of the outer lamellae; but the Clifton adult, J3, was known to be more than 7 years old. In *Ca*, *Cb* and *Cc* (§ 4), which are all intermediate in bill size between J3 and J4, the spacing of the marginals also falls within the same size range (tables 5 and 6).

The inrolling of the distal marginals on the upper jaw is important, because it prevents the gape from being fully closed. Even if the marginals close on the surface of the lower jaw between the lower outer lamellae, they leave a gape of nearly 2 mm (figures 8 and 21, plate 14).

#### *The lamellae of Phoenicopterus ruber*

The form and size of the lamellated areas are closely similar to those of *Ph. antiquorum*. The **inner lamellae** in the male and female adults, B546 and B542, also appear similar to those of J4 (of similar bill length, table 1); but no material has been available for microscopical examination or measurement.

The **outer lamellae of the lower jaw** have the same serrated form and height as those of *Ph. antiquorum*. The **spacing** is almost the same as that of J4 (*il*, table 6).

The **outer lamellae of the upper jaw** present the greatest difference from *Ph. antiquorum*. The form and size of the marginal hooks and leaflets is the same; but between E and C the hooks are so much rolled inwards as to have their spines almost horizontal, with the points facing not only inwards but slightly upwards towards the roof of the mouth. In consequence, the vertical **height** of these lamellae is reduced to less than 0.5 mm, instead of 1.5 mm. Between F and E, near the tip, and again from B proximally, they hang down more nearly vertically, as in the other species; but they are relatively short, and must allow the gape to close more nearly than in *Ph. antiquorum* (Ridgway 1896, figure 2,

plate XXIX). The **spacing** of the marginals (*il*, table 6) suggests a sex or age difference; in the female *Ph. ruber* it is similar to that in the juvenile female of *Ph. antiquorum* (J4). In the male *Ph. ruber*, with a bill length of 12.2 cm, the spacing is nearly as wide as in the larger adult *Ph. antiquorum* (J3), with a bill length of 13.0 cm (cf. tables 5 and 6). The latter is probably a female.

TABLE 6. LAMELLAE OF *PHOENICOPTERUS* SPP.

Measurements of the lamellae of a juvenile specimen of *Ph. antiquorum* (J4), compared with those for *Ph. ruber* (m. = B546, f. = B542) and *Ph. chilensis* (B8). All measurements in millimetres, corrected to 0.03 mm, with symbols as in tables 3 and 4.

position ...	upper jaw				lower jaw			
	AN	B	D	F	AN'	B'	D'	F'
	outer lamellae							
type: <i>Ph. ant.</i> juv.	Pls	Pls	Pks	Pks	Ss	Ss	Ss	Ss
<i>Ph. chilensis</i>	Pls	Pls	Pks	Pks	Ss	Ss	Ss	Ss
<i>Ph. ruber</i>	Pls	Pls	Pks	Pks	Ss	Ss	Ss	Ss
<i>h</i> : <i>Ph. ant.</i> juv.	0.66	1.8	2.2	0.9	0.2	0.5	0.4	0.2
<i>Ph. chilensis</i>	0.4	0.6	1.1	1.1	0.16	0.56	0.53	—
<i>Ph. ruber</i> m.	—	2.1	0.4	0.4	{ 0.2	0.5	0.8	0.5}*
<i>Ph. ruber</i> f.	—	—	0.3	0.6				
<i>il</i> : <i>Ph. ant.</i> juv.	0.36	0.6	1.03	0.9	0.23	0.5	0.56	0.5
<i>Ph. chilensis</i>	—	0.6	1.03	1.1	0.2	0.56	0.66	0.63
<i>Ph. ruber</i> m.	0.43	0.8	1.33	1.1	0.26	0.43	0.56	0.56
<i>Ph. ruber</i> f.	0.43	0.7	1.16	1.0	0.23	0.43	0.56	0.5
	inner lamellae							
<i>il-th</i> : <i>Ph. ant.</i> juv.	0.06	0.1	0.16	0.16	0.1	0.1	0.13	0.1
<i>Ph. chilensis</i>	—	—	ca. 0.13	—	—	0.13	—	—

\* Recorded as 'same as *Ph. antiquorum*', dimensions for which are interpolated from table 5.

#### The lamellae of *Phoenicopterus chilensis*

There is no great difference in the extent of the lamellated areas in this species from the others; but measurements of the **inner lamellae of the lower jaw** are only available from an area near B', where their **height** varies from 0.06 mm at the median edge to 0.2 mm at the lateral, and their **spacing** is about 0.16 mm. These measurements are not significantly different from those for *Ph. antiquorum* (table 4). The **inner lamellae of the upper jaw** do, however, seem to be rather different. Their **thickness** and pattern is as before; but the **height** of the inner series is greater and more irregular than that of *Ph. antiquorum*. The platelets from F to B look higher by direct observation, and measurements made on microscopical preparations from an area near D confirm this. Many reach a height of 0.6 mm or over, which is half as high again as any platelets in a similar area of *Ph. antiquorum*. Platelets decrease in height from the middle of the lamella towards the median edge, as they do in *Ph. antiquorum*; but they also decrease outwards to a minimum next to the tall submarginals. The individual form of the triangular platelets (figure 10c) is little different from those of *Ph. antiquorum* (figure 10a). The inter-lamellar **spacing** is rather closer than in *Ph. antiquorum*.

The **outer lamellae of the lower jaw** of *Ph. chilensis* differ slightly from those of *Ph. antiquorum* in having more sharply pointed peaks with deeper notches between them, tending to separate them into platelets (figure 10d). Their **height** is normal, but their rather narrow **spacing** resembles that of the juvenile female specimen of *Ph. antiquorum*,

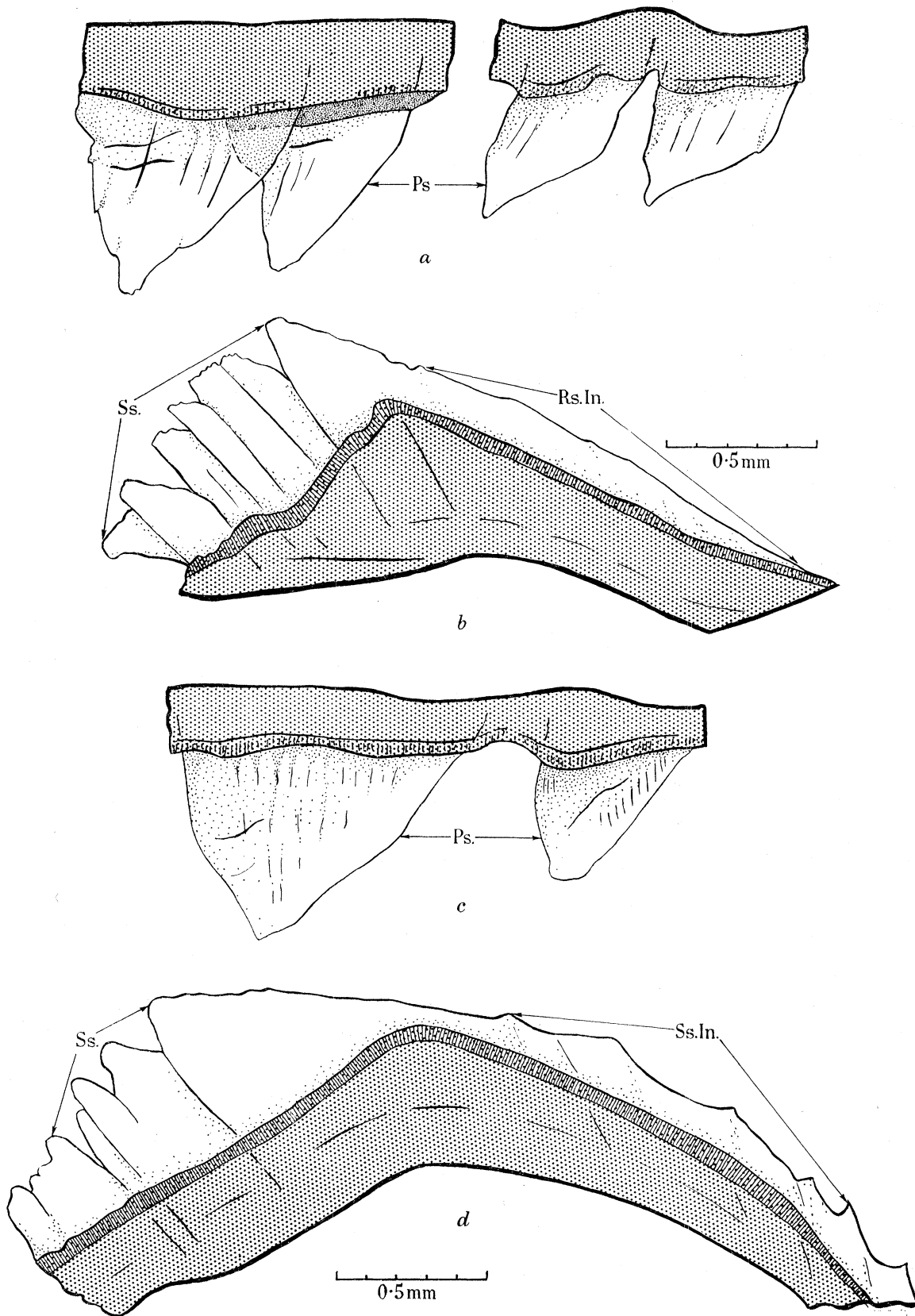

FIGURE 10. Lamellae of *Phoenicopterus*, orientated as in figure 8a. (a) *Ph. antiquorum*. Two pairs of inner platelets, Ps, from the distal part of the upper jaw. (b) *Ph. antiquorum*. One lamella from D' on the lower jaw with the outer part serrated, Ss, and the inner a smooth ridge, Rs.In. (c) *Ph. chilensis*. Two adjacent inner platelets, Ps, from the same lamella on the upper jaw. (d) *Ph. chilensis*. One lamella from the lower jaw with both outer, Ss, and inner parts, Ss.In., serrated.

rather than the adult. The **marginal** hooks and leaflets, formed from the **outer lamellae of the upper jaw**, are similar in form and almost as great in **height** as those of *Ph. antiquorum*; but again their **spacing** is nearest to that of the juvenile specimen (tables 5 and 6). The **submarginals** are clearly visible in this specimen, at least two standing between each of the distal marginals, and greatly exceeding (0.56 mm) the rather low adjacent inner lamellae (0.3 mm) in height.

#### 6.2. *Lamellae of flamingoes with deep-keeled bills*

##### *The lamellae of Phoeniconaias minor*

The following description is based on two adult specimens, J 1 and J 2, from Nakuru and a nearly full-grown juvenile, R 813 (p. 408). The latter has the lamellae in very good condition (see plates 15 and 16), and appears to differ little from the older specimens; its bill is rather shorter (table 2), but the spacing of the outer lamellae is almost exactly the same (tables 8 and 9).

The **lamellated areas** are much larger in this bill than in the shallow-keeled type (p. 426 and figures 24 and 25, plate 14). The area of contact between the two jaws is only 105 mm long, but so wide ( $bAi = 12.5$  mm at B' on the lower jaw and 13.0 mm at B on the upper) that the total area is about 35 cm<sup>2</sup> or nearly double that of *Ph. antiquorum* (cf. figures 2 and 5).

The **inner lamellae of both upper and lower jaws** are much alike and vary little from one part of the bill to another (table 3).

Low **undivided ridges** (Rf) occur on both lower and upper jaws in two places only; one being a very narrow strip, proximal to BN or BN', at the median edge of the area, and the other on the inner side of the horny tips T and T'. In the latter position the free edges of the most distal ridges are smooth; but proximally they begin to be divided into long low platelets and to acquire a fringed edge like that of all the other platelets.

A small **collecting trough** on the lower jaw of *Ph'naias minor* is a curious feature, for which there is no parallel in *Phoenicopterus*. This is formed by a single undivided lamella running, not transversely, but longitudinally along the extreme median edge of the inflexed border, at right angles to the rest of the lamellae. Its free edge curls inwards and upwards to form a shallow, fringed gutter at the inner edge of the filtering area, extending from F' to BN' (Rf.g., figures 11 and 29, plate 16).

The **platelets** (p. 422), instead of being confined to parts of the upper jaw only as they are in *Phoenicopterus*, cover almost the whole of the lamellated area on both jaws (figures 11 and 12), and have a highly characteristic appearance under the microscope, being tall, thin and frayed out into a fringe along their inner edge (Pf); but to the naked eye they make the strikingly regular pattern of diagonal rows, which become so fine towards the base of the bill as to be almost indistinguishable. All over the area the platelets are so thin and closely set that they give the appearance and feeling of velvet, and, if two pieces of the bill carrying this 'pile' are pressed together, they stick like a pair of small brushes and can only be made to slip past one another at all freely if the direction of movement is along, and not across, the direction of the diagonal rows (figures 26 to 29, plates 15 and 16). The tips of the platelets all point **inwards** (p. 424 and figure 11).

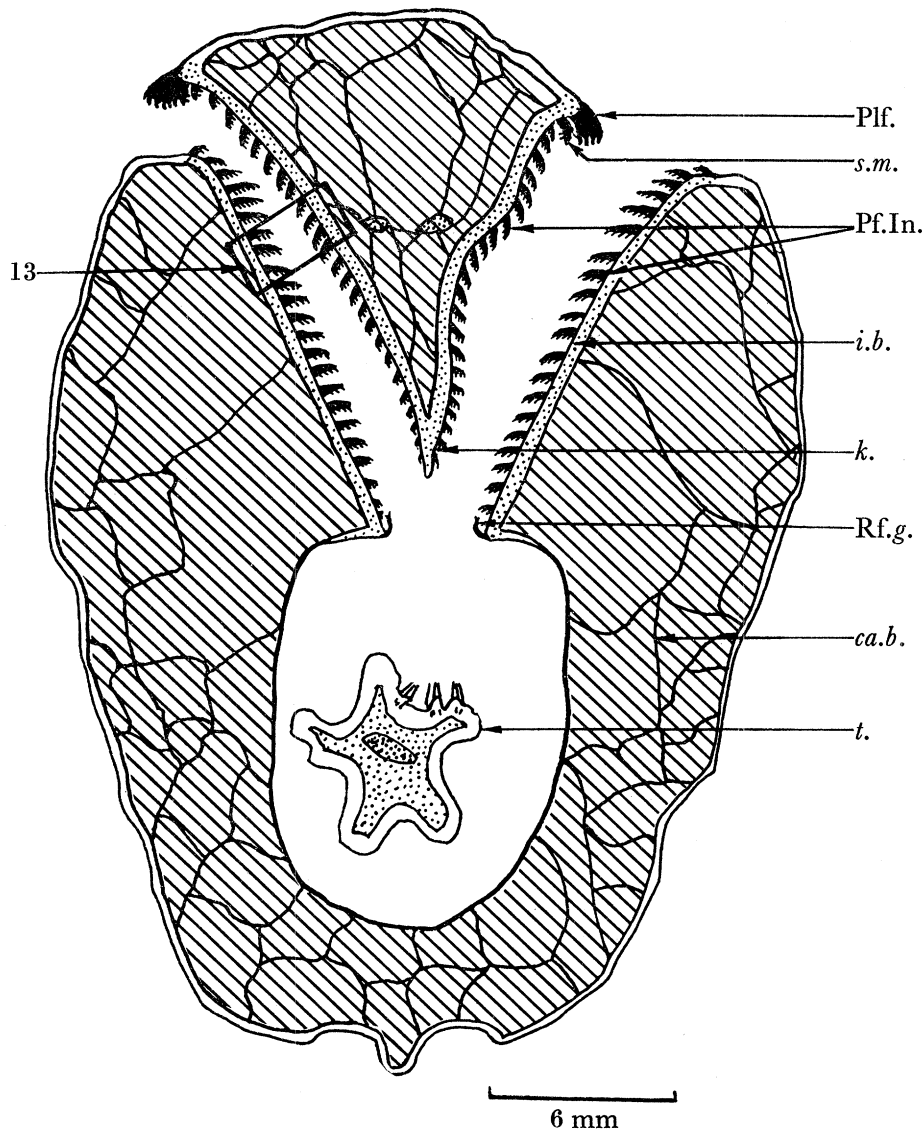

FIGURE 11. Transverse section of deep-keeled bill of *Ph'naias minor* (J1), on a slightly smaller scale than figure 8, from a camera lucida outline of a celloidin section of the whole bill near BN. The tongue, *t.*, is much shrunken by the method of preparation. A rectangle on the left, 13, shows the area which is enlarged in figure 13. *ca.b.* cancellous bone; *i.b.* expanded inflexed border of lower jaw; *k.* deep keel of upper jaw; Pf.In, fringed inner platelets on both jaws; Plf, fringed marginal leaflet on the lateral edge of the upper jaw; Rf.g. longitudinal fringed row forming a gutter along the median edge of the flat inflexed border; *s.m.* submarginal platelets.

The **orientation of the lamellae**, from which the platelets are derived on the upper jaw, is slightly forwards, as they pass inwards between AN and BN; transverse from BN to D, and slanting increasingly backwards, beyond D, until they become practically longitudinal on the inner side of the horny tip of the bill. The orientation on the lower jaw is practically the same, giving a slight convergence of the lamellae on both jaws towards the tongue papillae, rather than a strictly transverse orientation along the whole length of the bill.

The **thickness** of the platelets is less than that for *Phoenicopterus* (*th*, tables 4 and 7), the measurement at their base and thickened outer edge being between 0.02 and 0.03 mm,

while the blades taper down to about 0.005 mm towards both the fringe and the tip. The shortest platelets are the thinnest and are practically colourless, and transparent when unstained in balsam. A **fringe**, 0.05 to 0.06 mm long, always projects from the inner edge of the platelets on the side nearest to the tongue (figure 13). The thickness of the fibres in the fringe is 0.005 mm or less, and the rather irregular spaces between them rarely diverge to more than 0.01 mm (figure 14*a*).

TABLE 7. INNER LAMELLAE OF *PHOENICONAIAS MINOR*

Measurements of the inner lamellae of a late juvenile specimen, R 813, in millimetres measured to 0.01 mm (thickness to 0.005 mm). The position across the width of the lamellated area, where the measured platelet was situated, is indicated as lateral, midway or median; other symbols as in tables 3 and 4. Nos./mm<sup>2</sup> = numbers of platelets per mm<sup>2</sup> near the lateral or median edges of the lamellated area.

position	...	upper jaw				lower jaw				fringe
		AN	B	D	E	AN'	B'	D'	E'	
type	...	Pf/Rf	Pf	Pf	Pf	Pf/Rf	Pf	Pf	Pf	
<i>bAi</i>		9.0	13.0	7.0	5.0	7.0	12.5	7.0	6.0	
<i>h</i> : lateral		0.52*	0.68	—	0.16?	0.26	0.5	0.4	0.66	—
midway		0.1	0.56	0.7	—	—	0.4	—	—	0.06
median		0.13*	—	0.13	—	0.2	0.2	0.3	0.3	—
<i>th</i> : base		0.02	0.03	0.03	0.03	0.02	0.03	0.03	0.02	—
blade		...	0.005 to 0.01	...	...	...	0.005 to 0.01	...	...	0.005
<i>il</i> : lateral		0.11	0.15	0.09	0.09	0.05	0.14	0.08	0.1	—
midway		0.05	0.08	0.08	0.1	—	—	—	—	0.015†
median		0.06	0.09	0.11	0.14	0.05	0.08	0.08	0.1	—
<i>il-th</i> : maximum		0.09	0.12	0.06	0.11	0.07‡	0.11	0.05	0.08	—
minimum		0.03	0.05	0.05	0.06	0.03	0.05	0.05	0.08	0.01†
<i>ir</i> : lateral		0.21	0.35	0.42	0.35	0.17	0.3	0.3	0.3	
median		0.18	0.25	0.3	0.25	0.13	0.25	0.3	0.3	
nos./mm <sup>2</sup> : lateral		29	14	20	27	65	18	29	29	
median		98	46	30	27	175	40	35	35	

\* At BN.

† Distance between fibres of fringe.

‡ At BN'.

The **height** of the platelets (*h*, table 7) is smoothly graded along, and even more markedly across, the lamellated area, but at most points platelets facing each other across the gape are of about the same height on both jaws (figures 11 to 13). Along the lateral edge of the area their height decreases in both directions from maxima of 0.66 mm around E' on the lower jaw and 0.68 mm at B on the upper, to minima of 0.1 or 0.26 mm at either end of the bill. They also decrease in height from the margin towards the median edge of the lamellated area; on the upper jaw those at the median edge decrease both forwards and backwards from about 0.2 mm near B; on the lower jaw their greatest height is 0.36 mm at F', and decreases steadily to about 0.1 mm at Z'. Some of the smallest platelets may be little more than a base to carry an apical tuft of fringe (figure 14*b*). Proximally, the median end of each lamella persists as an undivided ridge (Rf, figure 27, plate 15), about 0.1 mm high, and carrying the usual 0.06 mm length of fringe.

There is apparently a rough correlation between the height of the platelets and their distance apart, and since the latter controls the spacing of the diagonal rows, the tallest platelets and the more widely spaced rows both occupy the distal part of the bill, the shorter and more closely set, the proximal areas (figures 26 to 29, plates 15 and 16). The taller platelets also tend to have a longer base of attachment than the shorter ones, but



the ratio of height to length is not constant; in the middle of the lamellated area typical platelets may be 0.45 mm high by 0.15 mm long, with a ratio of 3 to 1, while near the median edge they may be 0.15 by 0.23 mm, with a ratio of only 0.66 to 1. Nevertheless,

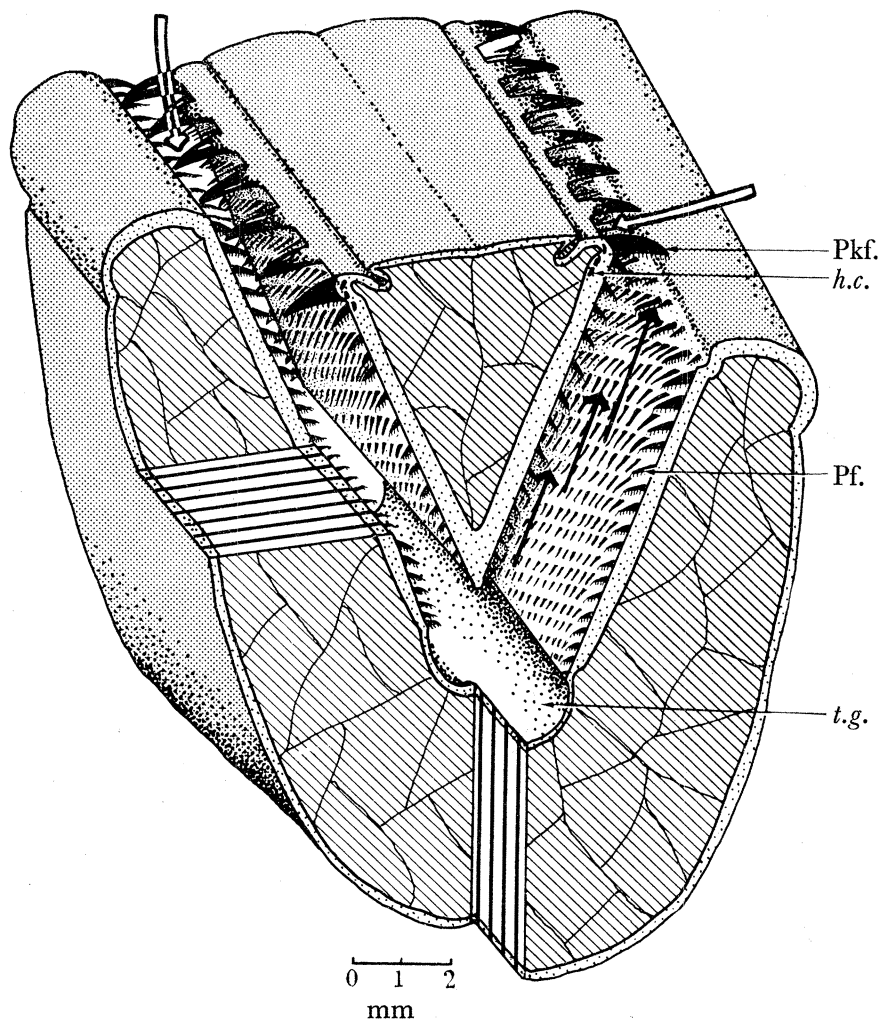

FIGURE 12. Perspective diagram of part of the bill of *Ph'naias minor* between D and E. Cut surfaces are indicated by cross-hatching, parts being cut back to different distances to expose lamellated areas of the keel and of the left ramus of the lower jaw (on the right in the diagram, which is viewed from the tip of the bill). The tongue is omitted from its groove, *t.g.*, for clarity; but its action in producing currents is indicated by the arrows: *white* for the *inflowing currents*, entering through the 'excluders' formed by the marginal hooks, *Pkf.*, on the upper jaw, and *black* for the *outflowing currents*, passing by the most efficient route through the succession of 'filters' formed by the fringed inner platelets, *Pf.*, on both jaws (for discussion, see pp. 475 et seq.). Herbst corpuscles have been identified for certain on the upper jaw at *h.c.* and under its dorsal surface; on the lower jaw they occur chiefly at the dorsal margin.

most of the platelets of *Ph'naias minor* have relatively short bases and are widely separated from the next in the same lamella as compared with those of *Ph. antiquorum*, which have long bases and are scarcely separated from one another (cf. figures 10*a* and 13). Whereas in *Ph. antiquorum* the diagonal grooves between the rows of platelets are shallow and their section is triangular, because of the encroaching bases of the platelets, in *Ph'naias minor*

they are clear channels of width  $ir$ , the distance from row to row, less a proportion of  $lp$ , the length of the platelet base, depending upon the angle at which this is set to that of the row. But the exact diminution of  $ir$  (table 7) is probably not very important as these grooves apparently serve only for the intake of food and water, for which they are amply large enough (see § 12·2).

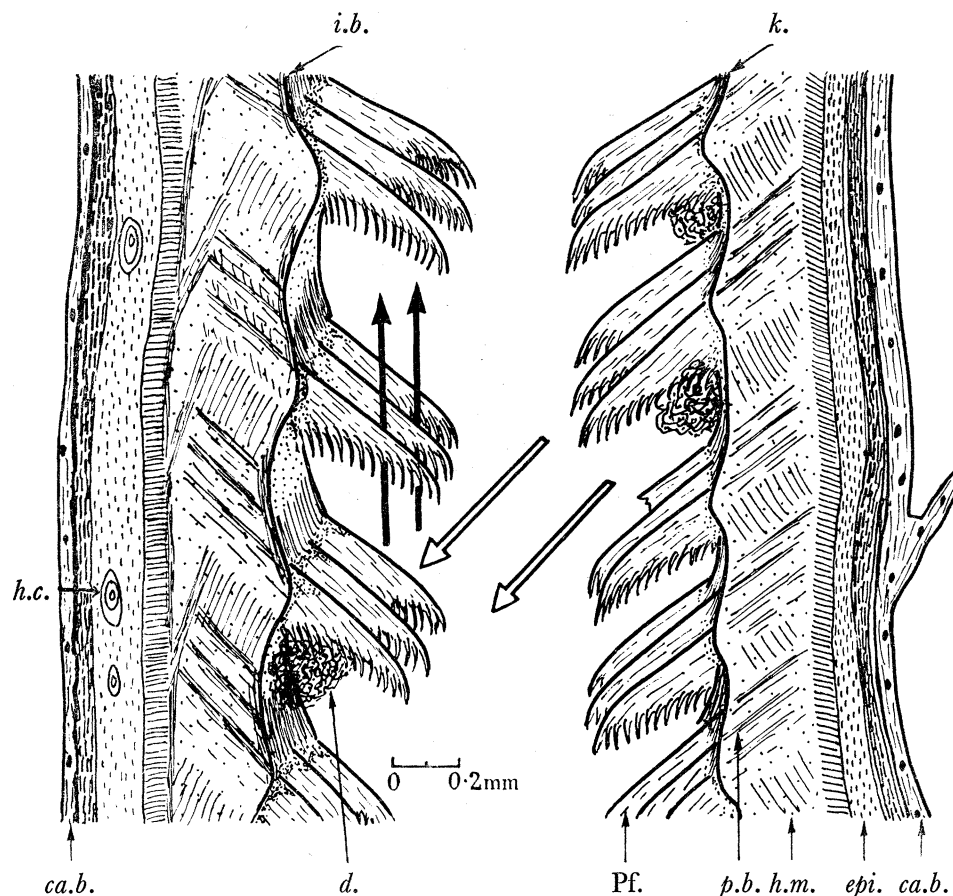

FIGURE 13. *Ph'naias minor*. Part of the celloidin section of the bill (figure 11) enlarged, showing fringed platelets, Pf, on the keel, *k.*, on the right, and on the inflexed border, *i.b.*, on the left. The tongue lies below the section, which is thick enough to show three lamellae broken into widely separated platelets, the groups of which belong to successive diagonal rows. A small bolus of debris, *d.*, probably representing food particles, is collected under some of the platelets. The orientation of the shading shows the direction taken by the main birefringent fibres in the horn. *White* arrows indicate the direction of the *inflowing food current*, between the diagonal rows of platelets; *black* arrows show the most efficient direction for the *outflowing current* (pp. 475 et seq.) through the fringes of platelets in adjacent lamellae (cf. figure 12). *ca.b.* cancellous bone; *epi.* jaw epidermis; *h.c.* Herbst corpuscle; *h.m.* horny matrix overlying epidermis; *p.b.* base of platelet running, through the matrix, to the epidermis.

The **pattern and distribution** of the platelets is at first sight strikingly regular, but closer examination reveals graded variations in the density of their distribution as great as from 13 to 175 per  $\text{mm}^2$  on different parts of the bill, as well as a consistently greater density on the lower jaw than on the upper (table 7). The two most obvious variables affecting the numbers of platelets in different areas are the spacing of the lamellae and of the rows; but

the angle between the lamellae and the rows affects the result and so do 'missing' platelets, which also affect the pattern.

The **spacing of the lamellae** (*il*) in *Ph'naias minor* is nearly twice as close as that in *Ph. antiquorum* (cf. plates 15 and 17, equally magnified) and apparently ranges from 0·06 to 0·2 mm, with a mean size of 0·12 mm on the upper jaw and 0·105 mm on the lower. Some of the wider spaces are caused by platelets in alternate lamellae being missing

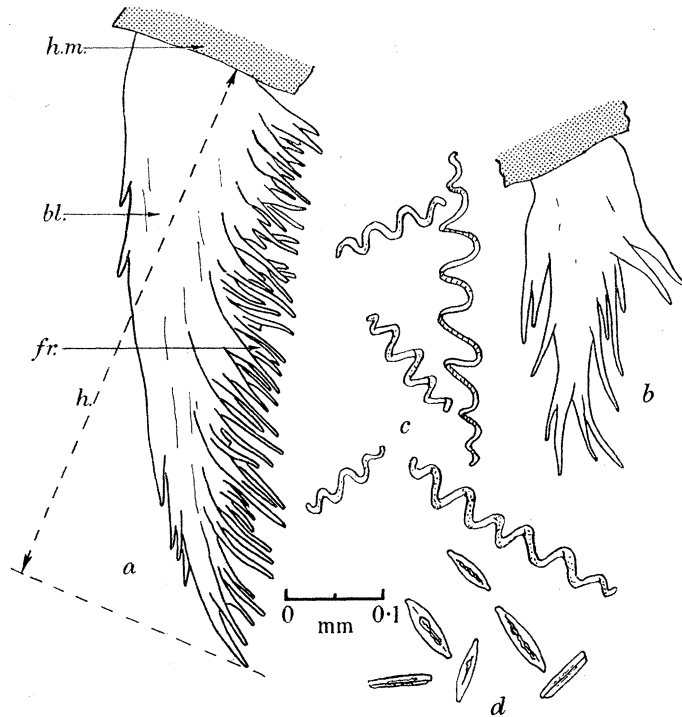

FIGURE 14. Platelets and food of *Ph'naias minor*, all enlarged to the same extent. (a) Fringed inner platelet, similar to those in figure 13, from a camera lucida outline. (b) Very small platelet from the proximal part of the lamellated area near Z. *bl.* blade of platelet; *fr.* fringe; *h.* height; *h.m.* horny matrix, through which platelet projects. (c) Coiled filaments of the alga, *Spirulina platensis*, drawn on the same scale as the filter postulated to catch them, i.e. the fringe on the platelet shown in 14a. (d) Frustules of the diatom, *Navicula* sp., taken from the stomach of *Ph'naias minor* after feeding on Lake Nakuru, 1934. Drawn on the same scale as the rest.

near the edges and ends of the lamellated area (figure 15); but the largest values of *il* occur near the bend on both jaws, and may in part be attributed to an effect of 'wheeling' round the bend.

The **spacing of the diagonal rows** (*ir*) varies greatly and may result in twice as many rows occurring in a proximal part of the lamellated area as in a distal part of equal size. On the lower jaw the rows run directly to the lateral margin with little change in appearance; but on the margin of the upper jaw most rows end regularly in a marginal hook or leaflet, though between every two or three of these there is an extra row, ending blindly (figures 26 and 27, plate 15), as in *Ph. antiquorum*. The direction of the rows on the two jaws is indicated in figure 5, where, relative to the free edge of the keel on the upper jaw, the rows run at an angle of 10° upwards and forwards near F, gradually rise to about 70° between B and BN, and drop back to 60° at AN; the direction of the corresponding rows

on the lower jaw is almost the same. The result is a marked convergence of the rows towards the proximal region of the tongue. This pattern has been indicated before by the shading in Geoffroy's figure 1 (1798) and Gromme's figure 357 (1930); but no one has mentioned that the rows are formed of separate platelets except Ridley (1954, p. 6), who says the 'ridges' have 'fine hairs protruding from them'.

Distally the changes in orientation of the lamellae, already mentioned, are in the same sense as these changes in direction of the rows, so that the angle between them remains practically constant at about  $30^\circ$  (figure 15); but near the base of the bill this angle increases to about  $60^\circ$ . This increase in angle should increase the **number of platelets per square millimetre** for any given values of  $il$  and  $ir$ , because each platelet stands at the intersection of a lamella and a row, and the lamellae are roughly parallel to one another and so are the rows. It follows that the more nearly the angle of intersection approaches a right angle, the shorter will be the intervals along the lamellae between the points of intersection, and, therefore, the greater the number of platelets per lamella or per unit area. Where the angle is constant the numbers of platelets do bear a fairly constant relation to the sizes of  $il$  and  $ir$ ; but proximally, where these values are smallest and the angle between them is large, the numbers of platelets, though very large (table 7), do not come up to this expectation. There is also a variation across the area; at D there are 30 platelets per  $\text{mm}^2$  near the median edge but only 20 near the margin, although the spacing and direction of the lamellae are nearly constant. This is mainly accounted for by the increase in the spaces,  $ir$ , between the diagonal rows as they approach the lateral edge (figure 26, plate 15). Similarly at D', on the lower jaw, the numbers of platelets in the main area range from 35 to 29 (table 7); but they change to 40 per  $\text{mm}^2$  at the extreme median edge (*i.b.*) and to 25 at the lateral (*m.*). These numbers would be about 52 and 40 respectively, because of changes in  $ir$ , were it not for 'missing' platelets (open circles, figure 15) apparently extending to positions far in from both edges in every other lamella. The position of each platelet is plotted in figure 15 from the photograph (area  $aa-a'a'$ , figure 28, plate 16); some interpretation as to their positions was needed, but the number of platelets per row is exact and the regularity of appearance of the original has been maintained. Clearly, changes in  $ir$  account for the gradients across the lamellated areas and 'missing' platelets for the ragged or slightly bald appearance of both edges, as compared with the centre of the area, with its full complement of platelets (figures 26 to 29, plates 15 and 16).

The **outer lamellae of the lower jaw** of *Ph'naias minor* are not obviously distinct from the inner lamellae as they are in *Phoenicopterus*. Towards the lateral edge of the lamellated area, where outer lamellae would be expected, alternate inner lamellae tend to stop short, as already described, and it seems reasonable to postulate that the remaining rather large and wide-set platelets represent the outer. But there is no sharp line of demarcation between inner and outer lamellae here; the two seem to overlap so that the outer have become integrated into the filter-forming pattern of the inner.

The **thickness** of the platelets on the outer part of the lamellated area is about 0.05 mm, and the **height** of the tallest may be as much as 0.7 mm. These last do not stand at the extreme margin, but have two or three platelets outside them, decreasing in height to the outermost (figures 11 and 28, plate 16). This is reminiscent of the heights of the peaks on the serrated outer lamellae of *Ph. antiquorum* (figure 8*b*). The **spacing** of these lamellae ( $il$ )

is about 0.2 mm, so that between C and D they stand at the outer ends of alternate inner lamellae (figure 15). They are rather longer at their base (0.3 mm) in proportion to their height (0.6 mm) than most of the inner platelets.

The **outer lamellae of the upper jaw** are subdivided into submarginals and marginal hooks and leaflets, as in *Ph. antiquorum*. The **submarginals** are all large fringed platelets

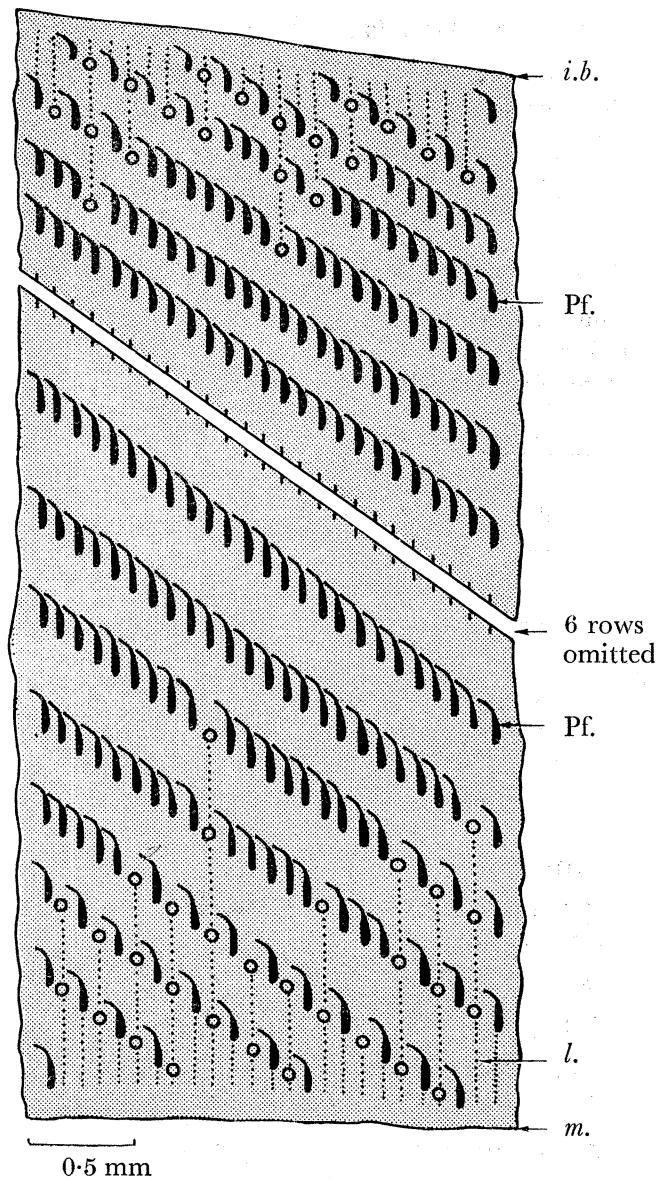

FIGURE 15. *Ph'naias minor*. Diagram of a surface view of a 2 mm. wide strip of the lamellated area near D' on the lower jaw, between *a-a* and *a'-a'* in the photograph, figure 28, plate 16. The *lateral margin*, *m.*, is shown at the foot of the diagram (to the right in the plate) and the *median edge* of the inflexed border, *i.b.*, at the top. The tip of the bill is to the right. In the middle of the area each original lamella is represented by one fringed platelet, Pf, in any given diagonal row. Six full rows, similar to those shown on either side of the gap, are omitted in the middle, to save space. At the lateral margin, five to seven lamellae, *l.*, stop short between the ends of the diagonal rows; but platelets are also missing (open circles, cf. figure 9, on a smaller scale). The same is true at the median edge, but produces a less noticeably ragged appearance there, than at the lateral margin in the photograph, figure 28. For further explanation see text (pp. 439 and 475).

carried on the same ridge as the marginals, at the edge of the jaw (*s.m.*, figure 11). Like the marginals, they are curled inwards more than the inner platelets. They are about the same **thickness** as the lower outer platelets, but rather taller, the maximum **height** near D being 0.9 mm. Their **spacing** is, like those of the ragged area of inners, one to every alternate inner of the close-set area, *il* being 0.13 mm at D (table 8), and increasing to 0.26 mm at BN.

The main diagonal rows of inner platelets continue as a row of submarginals, the number varying with the position along the bill (e.g. about six at D, figure 26, plate 15). All end in marginal hooks or leaflets, except the extra rows (*e.r.*), each of which ends in a submarginal. Proximally, the diagonal rows are more closely spaced, and include fewer submarginals, but extra rows still occur (*e.r.*, figure 27, plate 15).

TABLE 8. OUTER LAMELLAE OF *PHOENICONALIAS MINOR*

Measurements of the outer lamellae of a late juvenile specimen, R 813, in millimetres measured to 0.03 mm (thickness to 0.005 mm). *bAo* = breadth of area occupied by outer lamellae (this cannot be determined on the lower jaw, see p. 440); other symbols as in tables 3 and 4.

position	...	upper jaw				lower jaw				
		AN	B	D	E	AN'	BN'	B'	D'	E'
type	...	P1f	P1f	Pkf	Pkf	Pf	as inner			Pf
<i>bAo</i>		1.0	—	0.42	—	?	extent indeterminate			?
<i>h</i> : marginal		0.5	0.76	1.0	0.09	0.3	0.7	0.3	0.4	0.23
submarginal		0.6*	0.76	0.9	—	0.23	0.5	0.56	0.6	0.6
<i>th</i> : marginal		0.01	0.07	0.21	0.21	0.05?	—	—	—	0.02
sumarginal		0.03	0.05	0.05	0.03?	—	—	—	—	—
<i>il</i> : marginal		0.4	0.5	0.8	0.83	0.2	0.35	0.4	0.5	0.5
submarginal		0.16	0.2	0.13	0.1	...	(as inner, = <i>ca.</i> 0.1)			...
<i>il-th</i> : marginal		0.39	0.43	0.59	0.62	0.15	0.3	0.35	0.45	0.48
submarginal		0.13	0.15	0.08	0.07	...	(as inner, = <i>ca.</i> 0.07)			...

\* At BN.

The **marginal outer lamellae** on the upper jaw, like those of *Ph. antiquorum*, each form single hooks distally; they grade into leaflets, over a short distance between C and B, and continue backwards in this form, getting gradually smaller, to the base of the bill (figure 5). They form the 'Cordonnet crénelé' of Geoffroy (1798, p. 97). The gape is on the dorsal surface of the deep-keeled bill of *Ph'naias minor* (p. 415 and figure 23, plate 14), and distally the marginal hooks project laterally to cross the gape more or less horizontally. Although the hooks are curled slightly downwards, they do not anywhere get between the jaws, nor prevent these from closing, as happens in *Ph. antiquorum*. Like all the other platelets of *Ph'naias minor*, they have their lower surface deeply fringed (figure 7*g* and *h*).

The **thickness** of the leaf-like platelets between B and BN may be as much as 0.07 mm at the outer edge; but the blade tapers considerably to its fringe (figure 7*g*). Towards the base of the bill they become much thinner. The spines of the hook-like platelets range between 0.19 and 0.21 mm; but again the blades are much thinner than this. At the extreme distal end of the series (F) they become smaller and are little more than 0.1 mm thick. The distance that these platelets extend beyond the border of the upper jaw is taken to be their **height** (*h*, table 8), and comparable to *h* in *Ph. antiquorum*, although it is horizontal here instead of vertical. This, with *il*, determines the height and width of the

channels that lead through the gape of the bill, directly into the spaces between the diagonal rows (p. 439). In *Ph'naias minor* the height, which never exceeds 1.0 mm, is always less than in *Ph. antiquorum*, and likewise decreases from D to Z. The **spacing** of the marginals has been measured on eight specimens of *Ph'naias minor*. Although the measurements are not all complete (*il*, table 9), they show considerable uniformity, and give validity to those so far considered. They all show that the widest spaces occur between the distal hooks around E and F, and decrease rather suddenly at B, where the leaflets begin, and more gradually thence to Z. Apart from the young specimens R 806 (BT=6.1 cm) and R 823, the differences in *il* at C, for instance, are within the natural variability of the material and the errors of measurement, indicated by the figures for the left and right sides of the bill of R 792 (table 9).

TABLE 9. MARGINAL LAMELLAE OF *PHOENICONAIAS* AND *PHOENICOPARRUS*

Measurements of the inter-lamellar distance between the marginal platelets derived from the outer lamellae in millimetres to 0.01 mm; the bill lengths are given in table 2 in centimetres; *il* is found by counting the number of platelets in 50 or 100 mm and calculating the mean distance, rather than making individual measurements, which would show variation from one space to the next. The measurements in italics for 792 *l* and *r* are derived respectively from the left and right sides of the same bill. Positions as in figure 4a.

species ...	<i>Ph'naias minor</i>						<i>Ph'parrus andinus</i>	<i>Ph'parrus jamesi</i>	
	R 792 <i>l</i>	R 792 <i>r</i>	R 809	J 2	R 823	R 806	B 214	B 92	B 57
specimen									
sex ...	m.	m.	m.	f.?	juv.	juv.f.	f.	f.	?
<i>il</i> : at AN	<i>0.45</i>	<i>0.45</i>	0.45	0.5	0.48	0.42	0.7	—	—
at BN	<i>0.5</i>	<i>0.49</i>	0.63	0.52	0.5	0.42	0.7	0.52	0.45
at B	<i>0.6</i>	<i>0.51</i>	0.7	0.55	0.55	0.39	1.0	0.5	0.5
at C	<i>0.8</i>	<i>0.71</i>	0.8	0.77*	0.55	0.5	—	0.55	0.63
at D	<i>0.75</i>	<i>0.83</i>	1.0	0.72	0.79	0.71	1.05	—	0.5
at F	<i>0.85</i>	<i>0.87</i>	1.0	0.83	0.77	—	1.2	0.71	0.45

\* The measurement at C is the same for *Cr* (AT=10.1 cm), and for the young male, R 805, and the juvenile, R 813 (tables 7 and 8), both with AT=9.6 cm; that for the male, R 827, is 0.71 mm, and for the female, R 820, of similar bill length (table 2) is 0.55 mm. Some further data are deposited at the British Museum (Natural History), London.

*The lamellae of Phoenicoparrus andinus*

It has not been possible to make a detailed examination of the lamellae of this and the following species, because of the age of the material (p. 408). Even when visible within the bill, the lamellae are in many places clogged with dried debris, which obscures the detail. In the female specimen, B 214, which affords the best view, the lamellae are missing altogether in some areas. A few inner lamellae were cleaned and mounted to give the measurements and figures 16a and b.

The **lamellated area** is almost identical with that of *Ph'naias minor*, and is similarly covered by a velvet pile of separate platelets, diagonally alined; but it is not possible to see if the platelets give place to smooth ridges proximally. The total area is about 36.5 cm<sup>2</sup>, as the bill is slightly longer than in *Ph'naias minor*.

The **orientation** of both lamellae and rows appears similar to that in *Ph'naias minor*. It is also possible to see a distinct gradient of increasing size of platelets, from the base of the bill towards the tip, and also from the median edge towards the margin, along the length

of both jaws. The largest inner platelets are therefore to be found at the distal margin, as in *Ph'naias minor*.

The only **inner platelets of the lower jaw** that have been mounted and measured come from the median edge of the distal end of the inflexed border, near D'. The **thickness** of the platelets in *Ph'parrus andinus* is at least 0.02 mm. Like those of *Ph'naias minor* from the same position, they have the form of tall, narrow-based triangular platelets, but they have no fringe (figure 16*b*). The length along the axis of the largest platelet is 1.2 mm, which is more than the vertical **height** from the substratum, and is greater than any found in *Ph'naias minor* (maximum length = 0.96 mm). The length of the base, *lp*, is 0.2 mm, and is about the same in both species. Their **spacing**, *il*, is at most 0.15 to 0.23 mm, and is wider than that recorded for *Ph'naias minor* in the same area (0.08 mm); it resembles that of *Ph. antiquorum* (0.2 mm).

The only **inner platelets of the upper jaw** (figure 16*a*) that have been mounted and measured come from midway across the keel, just proximal to the bend. These platelets are broad-based low triangles ( $h = 0.25$  to 0.33 mm,  $lp = 0.25$  mm) similar in form to those of *Ph'naias minor*, from a similar position, and are within the size range of the latter ( $h = 0.2$  to 0.5 mm,  $lp = 0.1$  to 0.45 mm). Like the platelets from the lower jaw they differ from those of *Ph'naias minor* in having no fringe. Their **spacing** ( $il = 0.064$  to 0.1 mm) is also within the range of that of *Ph'naias minor*, and almost twice as close as those examined from a more distal part of the lower jaw. The space between the diagonal rows proximal to B is the same as in *Ph'naias minor* ( $ir = 0.33$  mm), but is wider distally ( $ir$  at D = 0.63 mm).

The **outer lamellae of the lower jaw** of *Ph'parrus andinus* are made up of platelets apparently similar in form to those in the adjacent inner lamellae, and are aligned with them in the diagonal rows. They were recorded as 'very tall, narrow platelets', without fringe, increasing in **height** distally from 1.1 to about 1.5 mm; but otherwise like the corresponding lamellae of *Ph'naias minor*. The distances between the end platelets in adjacent diagonal rows increase distally, being 0.42 mm at AN', 0.55 mm at BN', 0.9 mm at B' and 1.0 mm at C'. There are no measurements of the inter-lamellar **spacing** of adjacent platelets derived from the outer lamellae; but if it is double that of the platelets derived from the inner, as it is in *Ph'naias minor* (figure 15), *il* would here be about 0.3 to 0.5 mm.

The **outer lamellae of the upper jaw** can be seen to be divided into submarginals and marginals, much as in *Ph'naias minor*. The **submarginals** are similar in form to the inner platelets, but more than twice as high as these ( $h = ca. 0.9$  mm), though only half the height of the marginals. There are no records of their spacing or variation. The **marginals**, especially the leaflets, are closely similar to those of *Ph'naias minor*. The distal hooks project horizontally across the gape in the same way, but are heavy straight spines, very slightly bent downwards at their tips (figure 6*b*). Their **thickness** has not been measured. The vertical **height** of the marginals varies in the male from 1.0 to 3.0 mm, and in the female from 1.6 to 2.5 mm. The **spacing** (*il*, table 9) is greater than in any specimen of *Ph'naias minor*.

#### *The lamellae of Phoenicoparrus jamesi*

The **lamellated areas** have the same general form as those in the other species with deep-keeled bills. They are, however, peculiarly small in size, because the bill is relatively short below the bend (B to T in figure 6*c*), and the upper jaw is extremely narrow; in



consequence, both upper and lower lamellated areas are very shallow, and their total extent is estimated at 11 cm<sup>2</sup>, or less than a third of that in either of the other two deep-keeled species.

The **inner lamellae**, as far as can be seen, are all subdivided into platelets closely similar in size to those of *Ph'naias minor*, and, like them, carry a fringe on the side next to the tongue. Nothing can be seen of the lamellae proximal to the bend in either specimen, but distally the platelets are alined in diagonal rows as in the two previous species. The

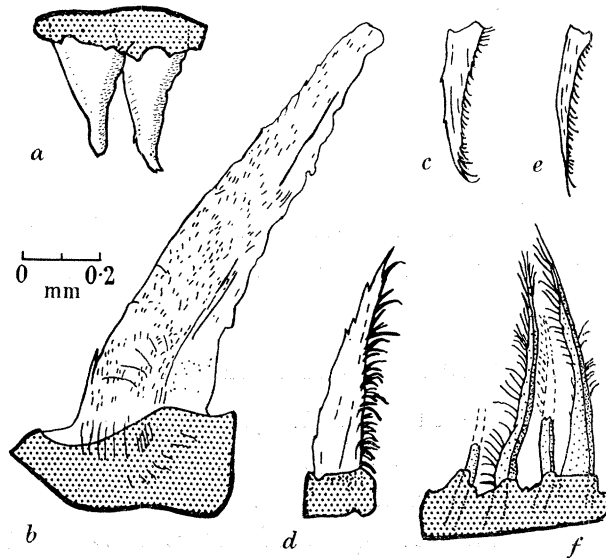

FIGURE 16. Inner platelets of *Phoenicoparrus*, on the same scale as figure 10. (a) Smooth platelet of *Ph'parrus andinus* from the upper jaw between B and BN, in the middle of the lamellated area. (b) Smooth platelet of *Ph'parrus andinus* from the margin of the lamellated area near D' on the lower jaw. (c) and (e) Fringed platelets of *Ph'parrus jamesi* from the upper jaw near B, both broken off short. (d) Fringed platelet of *Ph'parrus jamesi* from the lower jaw near E'. (f) Two platelets, from the same place as that shown in (d), seen edge on, to show the inter-lamellar spaces, crossed by the fringes (somewhat damaged in this material, which had been dry for many years). The dotted outlines show positions where platelets are clearly broken off short.

platelets that have been mounted come from the lower jaw, near E', and from B on the upper. They are closely similar to those of *Ph'naias minor* from similar positions, differing only in their rather narrower base (figure 16c to f). At E' the bases are 0.1 to 0.15 mm and at B 0.06 to 0.08 mm. Their **thickness** is about 0.015 mm, with a fringe spread of about 0.07 mm. Their **height** at E' is 0.5 to 0.6 mm and at B 0.35 to 0.4 mm. The height appears to decrease from the lateral to the median edges of the areas on both jaws, though there are no measurements. There is also a gradation in height along the length of the jaws, as in other species. The only measurement of **spacing** (*il*) is 0.1 mm, from the lower jaw at E' (figure 16f). The **fringe**, measured on platelets from both jaws, appears in some to be shorter than that in *Ph'naias minor*, but this may be due to damage. On others it is just the same length. The thickness of the fibres themselves (0.004 mm) is less than in *Ph'naias minor*, and the spaces between them appear to be just under 0.01 mm; but they are certainly of the same order of magnitude, and would provide a closely similar filter.

The **outer platelets of the lower jaw** are clearly similar in shape to the inner, appear also to be fringed, and are alined with them in the diagonal rows. There are no

measurements of their size, which grades down into that of the inners. The spacing between the platelets at the ends of the diagonal rows (one to every four or five inner lamellae) is 0.4 mm at BN', 0.5 mm at B' and 0.7 mm at E', which is rather more widely spaced than in *Ph'naias minor*, but closer than in *Ph'parrus andinus*.

The **outer marginal platelets of the upper jaw** form seemingly fringed hooks and leaflets. The leaflets are thin and hang down nearly vertically proximal to the bend, and the hooks project horizontally across the distal part of the gape. The hooks only differ from those of *Ph'naias minor* in being thicker (0.36 mm), blunter, and rather longer; they become less spine-like near the bend of the bill. The **heights** were recorded (in mm) as:

	AN	BN	B	C	D	F
female (B92)	1.1	1.2	2.0	2.5	—	2.1
unknown (B57)	—	0.6	1.8	—	2.3	2.2

Their **spacing** (table 9) is rather closer than in the young *Ph'naias minor* and, as the thickness is greater, the actual spaces between these marginals must be less than in any other species.

## 7. STRUCTURE OF THE TONGUE AND PALATE

Gadow (1891, p. 665) pointed out that the tongue of flamingoes is softer than that of any other bird; it is also unusually large and fleshy. The tongue may, therefore, have more power of changing shape than have the harder tongues of most birds, and this may help it to collect food from the filters for swallowing; but its main movement must be fore and aft, to provide the pumping force for filtration (§ 13.1).

### 7.1. *Tongue and palate of Phoenicopterus*

The external form of the tongue of *Ph. antiquorum* (figure 1) is best described in Owen's (1832*a*, pp. 142 and 143) very complete account, which has been fully confirmed by the writer: it 'is almost cylindrical' (length 12.2 cm along mid-dorsal line from glottis to tip; circumference at the bend 6.4 cm), 'but slightly flattened above and obliquely truncate anteriorly, so as to correspond with the form of the inferior mandible. The lower part of the truncate surface is produced into a pointed form, and is supported beneath by a small horny plate. Along the middle of the flattened superior surface there is a moderately deep and wide longitudinal furrow, on either side of which there are from twenty to twenty-five recurved spines, but of a soft and yielding texture, measuring from [4 to 6 mm] in length. These spines are arranged in an irregular alternate series; the outer ones being the smallest. . . .'

These large spines (*sp.r.*) are a striking peculiarity of this flamingo's tongue (figure 21, plate 14 and § 13.1). They are all simple pointed horn-covered structures (figure 17*a*). The most anterior spines, near B, are 5 mm high, whence they decrease in size posteriorly to 2 mm. The drawing by Duvernoy (1836, figure xii, plate III, reproduced in Gadow 1891, figure 29, Tafel XXXI) shows them all too much alike in size. McCann (1940, p. 25 and plate VII) gives a good description, and photographs that include a surface view.

Owen (1832*a*, p. 143) describes the tongue's armature, which is not unlike that of many Anseres, thus: 'At the posterior part of the tongue there are two small groups of smaller recumbent spines directed towards the glottis.' One group stands up on each side along

the dorso-lateral edge of the tongue, and consists of spines 1 or 2 mm long (*sp.v.*, figures 1 and 1*a*), very closely set, in two overlapping rows; the other groups of similar size lie almost flat and directed backwards on the dorsal surface of the tongue, with their spines closely set to form two small fans (*sp.f.*), each nine or ten spines wide, one on either side of the mid-line. McCann (1940, p. 25) refers to them as 'pectinate papillae'; but, although

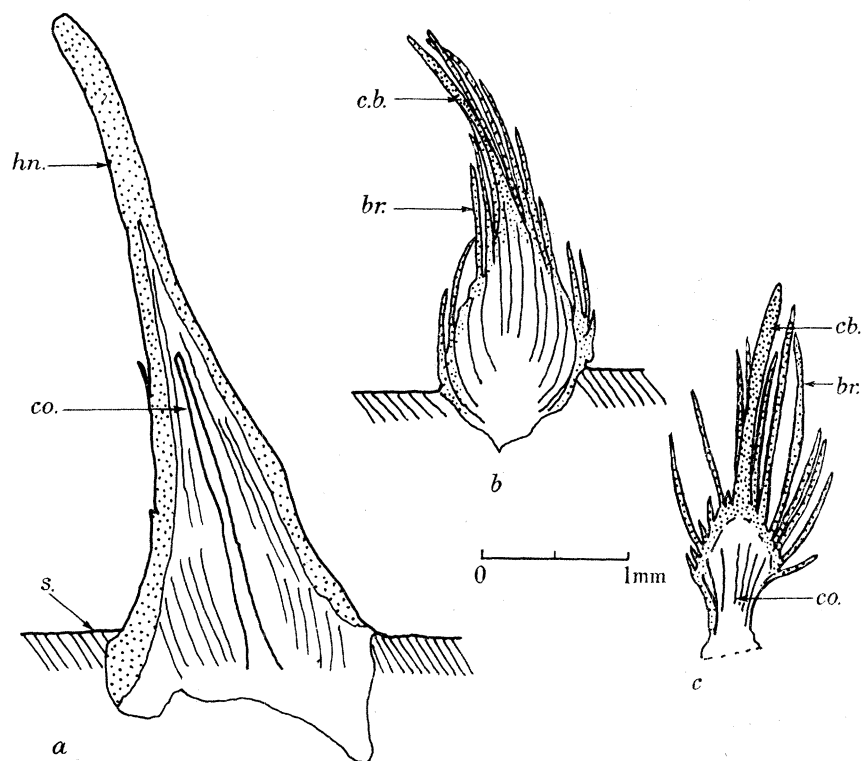

FIGURE 17. Isolated recurved tongue spines, cleared and drawn in optical section. (a) *Ph. antiquorum*. The horn, *hn.*, covering the core, *co.*, is practically undivided. The spine can be traced below the soft horn, *s.*, covering the surface of the tongue. (b) *Ph'naias minor*. The horn is subdivided into many thin bristles, *br.*, surrounding a larger central bristle, *cb.* (c) *Ph'naias minor*. The same kind of spine as *b*, but with the bristles spread out by squeezing the lower part of the core, *co.* The magnification is only  $\times \frac{2}{3}$  that of the platelets in figure 16.

this gives a good impression of the form, the spines are, in fact, separate. Other spines cluster round the very small entrance to the oesophagus, pointing down into it and situated, some on the posterior surface of the raised skin round the glottis, and some on the dorso-lateral wall of the pharynx above. There are also small, backwardly directed papillae of softer substance farther forward on the palate. There is a well-developed ridge of smooth skin running transversely across the floor of the mouth to form an epiglottis (*ep.*), immediately in front of the long, slit-like glottis (*gl.* figures 1 and 1*a*).

Internally, the tongue of *Ph. antiquorum* 'is supported by a long and thin concave cartilage, articulated to the body of the os hyoides by a shallow ginglymoid joint,\*

\* I am indebted to the late Dr G. P. Bidder for an illuminating exposition of this word. It is derived from γίγγλυμος, a door-hinge, and should, therefore, imply movement about one axis only and not free motion, despite Liddell and Scott's translating it as a 'ball and socket' joint. The uncertainty doubtless arose because early hinges were composed of two ball (or cylinder) and socket joints on the same axis, one at the top and the other at the bottom of the door. I believe Aristotle uses γίγγλυμώδης of the hinge of a bivalve.

allowing of a free motion' (Owen, 1832*a*). The hyoid skeleton (*h.a.* and *l.c.*, figure 2) is unusually large, and the drawing by Duvernoy (1836, figure xiii, plate III) is reasonably accurate, but does not make clear the form of the ginglymoid joint, nor have I been able to satisfy myself on this point from the skeletons that I have examined. The distribution of the muscles, of which there appears to be no published figure, must have an important effect upon the possible movements and use of the tongue. There are no signs of complex, interlacing fibres, such as make the tongues of parrots so mobile; instead, all the muscles are straight and, with the sole exception of the hypoglossus (*h.m.*), confined to the base of the tongue, and are inserted on the connective tissue behind the relatively solid cellular substance packed with oily fat (*n.m.*, figure 2). The tendons of the two hypoglossus muscles\* 'run along the under part of the lingual cartilage and expand to be inserted at its extremity, where a few fibres again proceed forwards to the extreme point of the tongue' (Owen 1832*a*). This muscle must bend the lingual cartilage and the non-muscular portion of the tongue, to make them conform to the curve of the lower jaw. The mass of muscles at the base draw the tongue backwards as much as 3 cm, like a piston within a cylinder (McCann 1940, p. 24). The forward drive must result chiefly from the elasticity of the tissues, perhaps aided by changes in curvature of the tongue itself. The movement is similar to that in other birds (Stadtmüller 1938, p. 957), and results in a pumping action, which is confirmed by observations on the feeding behaviour (p. 453).

In dried specimens of *Ph. ruber* no tongue was present; but Audubon (1827 to 1838, figure 431, 6 and 7, and 1839, p. 261) agrees with Owen, unless a difference is implied by the statement 'having at its base on each side *three series of very pointed papillae*'.

The spirit specimen of *Ph. chilensis* had the tongue preserved in position and, as far as could be seen, it was of the same form and carried similar spines to those of *Ph. antiquorum*.

#### 7.2. *Tongue and palate of Phoeniconaias*

Geoffroy (1798, p. 98), in his original description of *Ph'naias minor*, commented on the way that the inflexed borders of the lower jaw reduced the space left for the tongue, and wondered what effect this might have upon the mode of feeding (and incidentally upon the edible qualities of the flesh!); but he offered no solution to this problem and none has been offered since.

The tongue is much smaller than that of *Ph. antiquorum*. Its length in an adult is only 8.8 cm; at its base, where it is oval in section, it measures 1.3 cm vertically and 0.8 cm across, while at the bend it is more nearly circular in section, measuring 1.2 cm vertically and 1.0 cm across and is only 4 cm in circumference. It fits very closely into the limited space within the almost tubular lower jaw (figure 5), so that movement must be restricted almost entirely to fore and aft pumping. Only towards the tip, where it tapers rapidly, would it seem to have a little free play, allowing a dorso-ventral movement of perhaps 2 mm. It has a horny support under the tip, similar to that of *Ph. antiquorum*, though smaller and more pointed. Dissection shows the internal structure to be essentially similar to that of *Ph. antiquorum*.

\* Cf. *Hypogloss. ant.* in *Anas bochas* (Edgeworth 1935, p. 442, figure 635*c* and *d*). Owen called these 'hyoglossi'; but they are shorter and more nearly median than the muscles of this name shown in the same figure.

The papillae or recurved spines (*sp.r.*, figures 5 and 5*a*), set along either side of the tongue from the bend back to within 16 mm of the glottis, are smaller and more numerous than those of *Ph. antiquorum*. On either side, the main row consists of about fifteen spines, increasing slightly in diameter towards the back of the row, but not differing much in height, the shortest being less than 0.5 mm, and the tallest no more than 2 mm. There are irregular rows of smaller spines alongside these, set in a single row on the inner side, and a double row at the outer side; so that there may be four spines abreast near the front end of the series. There are fewer accessory spines farther back.

The horny covering of the tongue spines of *Ph'naias minor* is split at the tip like a paint brush composed of a varying number of flexible, graded bristles (figure 17*b*) surrounding a large and relatively stiff central spine. Squeezing the base of an isolated spine with forceps causes the bristles to stick out all round, rather like a bottle brush (figure 17*c*), and it is possible that a similar effect might be produced in life by muscular effort, or by pressure of the whole tongue against the overhanging free edge of the border of the lower jaw. If so, the bristles may serve to increase the food-collecting efficiency of these spines.

The spines at the base of the tongue have much the same arrangement of an upright row (*sp.v.*) at each side and two double fans (*sp.f.*), backwardly directed between them, as in *Ph. antiquorum*; but all are much smaller and fitted to the smaller size of the tongue. The larger spines in this part are no more than 1.0 mm long (figure 5*a*).

The epiglottis (*ep.*) is a smooth transverse ridge and is similar to that of *Ph. antiquorum*; the long glottis has bristles behind it which point down into the oesophagus, as do those on the dorso-lateral walls of the pharynx; but the bristles are only about half the size of those in *Phoenicopterus*.

The papillae on the palate are also small and form a single row where the keel flattens out on the upper jaw. They then divide into two rows, diverging on either side of the soft palate behind the lamellae.

### 7.3. *Tongue and palate of Phoenicoparrus*

There is at present no information available about the tongue or palate of either species of *Phoenicoparrus*. They do not appear ever to have been described; they had been removed, with the other soft parts, from the dried specimens.

## 8. SENSE ORGANS ON THE BILL AND TONGUE

### 8.1. *Sense organs of Phoenicopterus*

Two types of corpuscular sense organs lying under the horny skin of both jaws were described by Jobert (1872, p. 12) as being more numerous in the 'Flamant rose' (*Ph. antiquorum* presumably) than in any other bird, except the woodcock (*Scolopax*). He says they occur on both outer and inner surfaces of the bill, especially near the tip. Schildmacher (1931, p. 396) adds that they are particularly abundant towards the edges of the bill and under the skin of the palate, and identifies them with the Herbst and Grandry bodies, characteristic of the bills of many other water birds. The Herbst corpuscles are the larger of the two; they are often deep-seated in the cutis, and always contain many sense cells, lying along either side of a bundle of nerve fibres, surrounded by connective tissue to form a short cylinder, which has its long axis parallel to the skin surface. The Grandry

bodies are smaller, rounded organs, which usually contain only one sense cell; they are said to penetrate into the tips of cutis papillae, and to underlie the horny lamellae on the jaws, but I have not seen them in the present material. Both sense organs can also occur in the dermal papillae of the tongue, as in ducks (Plate 1924, p. 50, and figures 45 to 47).

Schildmacher (1931, p. 396) re-examined the function of the Herbst corpuscles, and considered the possibility of their reacting to changes in either blood pressure or osmotic pressure in the tissues; but he came to the conclusion, from their morphological arrangement, that they are used solely for detection of changes in mechanical pressure. He does not give any figure for their abundance in the flamingo, but the bill of *Anas platyrhynchos* has 27 per mm<sup>2</sup>, which Stresemann (1927 to 1934, p. 480) compares favourably with 23 Meissner corpuscles per mm<sup>2</sup> in the human index finger.

Thick sections near BN and D confirm the occurrence of Herbst corpuscles on the lateral part of the upper jaw, where they appear to underlie the marginal and submarginal platelets, but not any of the inner platelets. This observation is in general agreement with that given below for *Ph'naias minor*.

I have found no evidence of taste organs in the bill or tongue of *Phoenicopterus*, but the presence of an unusually large olfactory foramen in the skull suggests, as Dr H. P. Whiting has pointed out to me, that flamingoes may have a well-developed 'oral sense', comparable with that in ducks, due to the linking up of olfactory and somatic sense endings, such as those of the corpuscular organs, by quinto-telencephalar tracts in the end brain (Kappers, Huber & Crosby 1936, pp. 393 and 1394). The nerve dissections necessary to reveal these connexions have been outside the scope of the present investigation.

No information has been found on sense organs in the bill of *Ph. ruber* or *Ph. chilensis*.

#### 8.2. Sense organs of *Phoeniconaias* and *Phoenicoparrus*

Thick sections of the bill of *Ph'naias minor* (figure 11) show concentrations of structures, which may be Herbst corpuscles, below the tongue spines. Thinner sections of part of the upper jaw of R 823, fixed in Bouin's fluid, were stained in Heidenhein's haematoxylin, followed by Mallory B with oxalic acid. The Herbst corpuscles have the usual form and are easily located, appearing brilliant blue in contrast to the rest of the tissues. They lie under the lateral edge of the lamellated area (*h.c.*, figure 12); few extend under the inner platelets, but they underlie the dorsal surface of the bill, as in other genera. They are arranged singly, not in groups of four or five one below the other as in the bill of the snipe (Schildmacher 1931, p. 387, figure 5). In *Ph'naias minor* the Herbst corpuscles appear to be orientated with their long axis directed along the length of the bill. On the lower jaw most lie under the dorsal margin, but a few are scattered across the width of the lamellated area (figure 13) and under the skin on the outer surface.

No information on sense organs has so far been found for either species of *Phoenicoparrus*.

#### OBSERVATIONS

In order to postulate reasonable functions for the structures so far described, a number of observations on feeding movements, and on the kind and size of food and grit collected in the gizzard must be considered.

## 9. BEHAVIOUR AND BILL MOVEMENTS IN FEEDING

The normal feeding position for flamingoes is to swing the head down towards the feet and to adjust the level at which the bill is held by shortening or lengthening the S-bend in the long sinuous neck. The head is naturally inverted by this movement and is kept in this position while feeding, with the dorsal surface of the bill next to the substratum and the tip usually pointing backwards, as Gundlach (1875, p. 369) described. When fishing with only the distal part of the bill submerged, the bend allows the nostrils to remain above the surface; but when fishing at a lower level the whole head is submerged, as in bottom-feeding ducks.

This description applies equally to *Phoenicopterus* and to *Ph'naias minor* and presumably to *Phoenicoparrus*.

9.1. *Feeding in the field*

Earlier accounts of flamingoes, seen feeding in the distance, include Klingel's (1942, pp. 49 and 212) description of *Ph. ruber* 'raising and dipping their reversed shovel bills' in the water and 'scooping up the cerithiums as they moved', and Gromme's (1930, p. 438) account of *Ph'naias minor* on Lake Nakuru 'strolling down the strand in a most leisurely manner, sweeping the surface of the water with their beaks and feeding as they came'. In the field one cannot help being struck by the seeming regularity with which the flamingoes move forward, often in rows or groups, all swinging their heads from side to side, as they feed. There is, however, an important difference in behaviour of the two genera implied in these descriptions, and explained by Ridley *et al.* (1955, figures 2 and 3). They describe, with figures based on field observations and detailed cinematographic records, how the two species in Kenya, while feeding side by side in the same lake, actually collect their food from different levels: *Ph. antiquorum* collects chironomids and other organisms from the mud, while *Ph'naias minor* collects floating phytoplankton from the overlying water. If the water is shallow the difference in behaviour of the two species is not very noticeable; but in deep water the efforts of *Ph. antiquorum* to reach the bottom are much more obvious and, if the birds are swimming in water too deep for wading, may even lead to the body being 'up-ended' like that of ducks or swans (cf. Gallet 1949, p. 114). *Ph'naias minor*, on the other hand, can continue to feed with its bill only just submerged, however deep the water. In both species the head is usually swung from side to side or drawn like a scythe in great semi-circular sweeps around the feet as the centre. Just occasionally *Ph'naias minor* may walk rapidly forward, keeping the bill straight in front of its feet (Ridley, personal communication).

Another type of feeding behaviour has also been described by Gromme (1930, p. 438), probably in reference to *Ph'naias minor*: 'Whole companies' of the birds in a freshwater inlet on Lake Nakuru 'go through the peculiar, but highly utilitarian, motion of treading around and around, which for all the world looks as if they were dancing a jig'. By this means, while remaining on the spot, 'they glean the bottom for the . . . food stirred up by the rapid treading of the shallow water'. Gallet (1949, pp. 114 and 115, and figures on pp. 39 and 40) refers to similar behaviour in *Ph. antiquorum* in the Camargue, when the lagoons are drying up: 'Piétinant et talonnant sans cesse avec une extrême rapidité, ils promènent leur bec autour d'eux dans la vase en décrivant un cercle autour du pivot des

pattes qui, peu à peu, tournent sur elles-mêmes tout en piétinant. La vase mobilisée par l'action des pattes est fouillée et filtrée par le bec, et abandonnée à l'oiseau tout ce qui est organique; le résidu s'accumule en un monticule central, entouré d'une dépression circulaire périphérique.'

The jig movement seems only to occur in special circumstances and not to be a necessary accompaniment of all feeding. Gallet definitely associates it with feeding on mud, and not with the search for large food organisms. Gromme's descriptions also contrast the leisurely stroll of *Ph'naias minor* when feeding on suspended algae with their rapid jig in the freshwater inlet, and it is tempting to wonder if in the latter case there was a deposit of diatoms, or some other food organism heavier than water, that had to be stirred up before it could be collected by the filtering bill, or if the birds were collecting grit.

Lastly, *Ph. antiquorum* may use the tip of the bill to pick up small objects, though this seems to be rare. I have only seen it twice in adults: once when they were 'pretending to feed' on dry land (see below), and once when they were fishing whole shrimps out of a bucket of mixed food before biting them several times, but usually rejecting them in the end as unmanageable. It is also used by very young birds, while their bills are still straight (Chapman 1908, p. 189), although they receive most of their nourishment at this stage by regurgitation from the parents.

#### 9.2. *Feeding and other behaviour of Phoenicopterus in captivity*

The movements of living *Ph. antiquorum* were watched at close quarters in Clifton Zoological Gardens, and included preening, sparring with one another and feeding in a shallow pond, as well as a convenient demonstration given by two or three birds, carrying out what appeared to be 'feeding' movements over a dry patch of earth. The latter included the 'jig movement' described above, though nothing can have been collected except a little dust and fine stones. Even a small stone of no more than about 8 mm in diameter, though frequently gathered into the bill of one or other bird, was always thrown out again, and so were some detached blades of dry grass, which were often passed through the bill, as if being examined for attached organisms. The surrounding grass was never plucked and eaten as it would have been by geese.

It was noticed that the bill was often tilted somewhat down to one side or the other, as if to scoop material into it, as the head was swung to the same side, while the neck was so flexible that it could be rotated until the tip of the bill pointed almost directly forwards instead of backwards. Clearly, the bill could be made to glean the bottom of a lagoon with great thoroughness. The movements of *Ph. chilensis* in captivity are much the same as those just described for the related species.

#### 9.3. *Movements of the bill of Phoenicopterus antiquorum*

The maximum gape attained an angle of about 30° when the birds were sparring with one another; this separated the tips of the jaws by some 3.5 cm as in Plate's (1922) figure 235E. In preening and feeding, the greatest separation of the tips of the jaws was only about 1 cm.

The movement of the two jaws was easy to see in preening, as they remained in full view for much of the time. It was clear that either the upper or the lower might be moved to



about the same extent, with a distinct tendency for the bird to move whichever jaw was below at the time.

In feeding, the movements are very rapid and difficult to observe; but occasionally a good view can be obtained when the water is shallow enough to leave the base of the bill exposed. Then, the jaws were either held stationary or the upper alone was used with a rapid 'champing' movement. I could never detect any movement of the lower jaw in feeding, as I could in preening; but the whole head shakes so much, with the addition of the violent tongue movements, that it is difficult to be certain. Since, in the feeding position, the upper jaw is below, its use agrees with the observation that whichever jaw was below was moved in preening. Chapman (1908, p. 189) also came to the conclusion, from his field observations, that in *Ph. ruber* 'the lower portion of the bill is immovable, but the upper portion, moving rapidly, forces little jets of water from each side of the base of the bill, washing out the sand and the mud through the strainers with which the sides of the bill are beset and leaving the shells (of *Cerithium*) on which the bird subsists'. The jets of water are easy to see if the bill is not too deeply submerged; but I attribute them mainly to the action of the tongue, rather than of the jaws, since they persist when the jaws are apparently stationary. Examination of the head of a freshly killed specimen, in which the parts were still movable, confirmed the above observations. A detailed study of the muscles, such as Davids (1952) has been making on *Anas platyrhynchos*, would be extremely interesting in this connexion. The relation of the structure of the skull to these movements has already been mentioned (§ 5).

#### 9.4. *Movements of the tongue of Phoenicopterus antiquorum*

This movement, with or without that of the upper jaw, is very strenuous and shakes the whole head and adjacent part of the neck. The tongue itself (p. 446) cannot, of course, be seen; but its movement, or that of some of its muscles, shows clearly in *Ph. antiquorum* in the unfeathered region of the throat; the in-and-out movements of the muscles must coincide with the forward and backward drive of the tongue in its groove (figures 1 and 2). When the bill is partly out of the water, the inward movement of the muscle surface and the forward movement of the tongue appear to be synchronous with the jets of water shot out to a distance of about 8 cm on either side. Water is presumably also ejected through the submerged distal part of the gape. When the bill is fully submerged, the combination of the tongue-muscle movement and this 'exhalent' water current sets up rings of small waves travelling rapidly away from the bill. The rate of beat of the tongue is about four strokes per second.

Observation of the bill, when the flamingoes are on land and not feeding, fails to reveal any sign of the tongue, even when the bill is opened to its greatest extent. As this is so unlike other birds, it confirms the view that the peculiar inflexed borders of the lower jaw make it virtually impossible for the tongue to move out of the groove below them (figures 21 and 22, plate 14).

#### 10. KINDS AND SIZE OF FOOD EATEN

The only direct evidence to show that the bill and its movements achieve filter-feeding, is provided by the fresh stomach contents of birds, shot while feeding. The nature of the food and the sizes of the particles or organisms of which it is composed, give a measure of

what the filtering system can collect. The fact that the fresh stomach contents are almost dry shows, further, that these materials have been effectively filtered out of the water.

Direct evidence as to their food, derived from the examination of stomach contents, is only available for some species in some localities. Some indirect evidence seems trustworthy, and supplies useful corroboration; but there are other cases where items of food have been reported, and even copied from list to list, on evidence that seems little better than pure conjecture. An attempt must therefore be made to assess the validity of the published records, without forgetting the possibility of peculiar items of food being taken in unusual circumstances.

#### 10.1. *Food of flamingoes with shallow-keeled bills*

##### *The food of Phoenicopterus antiquorum*

Earlier records suggest a considerable variety in the diet, even omitting the more improbable items, such as sea-urchins. Mackworth-Praed & Grant (1952, p. 82) have recently summarized the food of this species in North Africa as consisting of 'water insects, shrimps, snails and other shells and also vegetable matter'; but this omits the size factor, and mud, both of which are important.

(a) *Small organisms as food for Phoenicopterus antiquorum in the field.* Records, substantiated by examination of stomach contents (Poncy 1926, p. 14), include small animals and seeds, as well as other plant remains. Poncy cites von Heuglin (1873, p. 1274) for Cladocera, worms, molluscs and vegetable matter for birds from north-east Africa; and Blanc (*in lit.*) as suggesting *Tubifex*. Ticehurst (1923, p. 439) gives small Crustacea, small mullet (fish) fry, and seeds of *Medicago lupulini* and *Cyperus* for specimens from the Rann of Cutch, India. Koenig (1888, p. 293) records a list including chironomid larvae from Tunis, and Clarke (1898, p. 480) gives presumptive evidence for *Artemia* for birds in the Camargue. Chapman (1884, p. 71) says that at Guadalquivir they 'tear up grasses and water plants'! Madon (1932, pp. 37 to 39) examined stomach contents of thirteen specimens from the Camargue; but the individual variation that he found may be abnormal, as none of the birds had managed to collect much food during the 'Mistral', which preceded his investigation. Plant remains were important in twelve out of his thirteen specimens and included seeds of *Juncus* (2 to 3 mm) in eleven birds, seeds of *Leesia* (2 to 2.5 mm) in two birds, and seeds of Papilionaceae (3.5 to 4 mm) in three birds. Animal material, composed chiefly of small gastropod molluscs (3 to 4 mm) including *Paludestrina acuta*, was abundant in eleven birds; 117 isopods, *Sphaeroma marginatum* (3 to 6 mm), were found in one bird. It was remarkable that none of these flamingoes had collected any insects, although other birds, such as grebes, were catching them in the same area. Yet Guichard (1951, p. 52) doubts whether small molluscs are eaten by flamingoes. Madon (1932) also discusses the possibility of flamingoes eating the relatively large bivalves, *Cardium* and *Mytilus*, which have often been included in lists of their food (e.g. Witherby *et al.* 1939, p. 165). Madon considers that the fragments of these shells found in the stomachs were so small and regular in size as almost certainly to have been collected by the birds in an already fragmented state, together with the usual sand and fine gravel; for, in his judgement, the flamingo's bill is too weak to break open living specimens of these bivalves. All the evidence I have seen confirms this view. Colonel R. Meinertzhagen

reported (in a letter to Lord Richard Percy, 23 May 1954) that the stomach contents from four specimens of *Ph. antiquorum* from Port Sudan and one from Somaliland all contained a mass of shells of *Tympanotomus fluviatilis* Potiez. This is interesting, as it is a subgenus of *Cerithium*, for long believed to be the sole food of *Ph. ruber* in Central America (p. 457). The shells of *Tympanotomus* varied in size from 2 to 12 mm. in height by 1 to 3 mm in greatest diameter, the majority being between 6 and 10 mm (personal observation on three samples kindly lent by Colonel Meinertzhagen).

Ridley & Percy (1953, p. 108) and Ridley (1954, p. 7) have recently published valuable evidence (amplified in Ridley *et al.* 1955, p. 148) on stomach contents of five specimens of this flamingo, taken when feeding on the alkaline Lake Elmenteita, in Kenya. Three specimens, obtained in 1951, all contained chironomid larvae, with the addition of a few corixid bugs in one bird, large copepods, *Paradiaptomus africanus* (Daday), in another, and seeds of the sedge, *Cyperus laevigatus* forma, in the third. The same copepods were found in both specimens obtained in 1952, with the addition of chironomid larvae in one of them. The relative uniformity of these results is made more significant by the fact that, whereas in 1951 the birds were feeding on the only living material available, in 1952 the lake supported a water-bloom of algae. As in 1929, these algae were the main food of *Ph'naias minor*, but only in one specimen of *Ph. antiquorum* was a significant trace of algae to be found throughout the length of the gut (Ridley *et al.* 1955, p. 149). This evidence makes it quite clear that, whether algae were present (1952) or not (1951), *Ph. antiquorum* only fed upon insects, copepods or seeds, all ranging in size between about 2 and 10 mm in their greatest dimensions.

In view of this, previous reports that *Ph. antiquorum* feeds on algae should be reconsidered. For instance, Gregory's (1896, p. 108) observation on Lake Elmenteita is open to doubt when he states that 'huge flocks of pink flamingoes (*Phoenicopterus roseus* Pall.) waded in the shallows . . . browsing on masses of algae, which in places imparted a deep green colour to the water'; for he mentions the presence of insect larvae and small crustaceans in the lake, but examined no stomach contents of the flamingoes. He may have confused the species as he makes no mention of *Ph'naias minor*, which is a characteristic inhabitant of this lake when the algae are present and looks 'pink' when standing, whereas *Ph. antiquorum* looks almost white. Moreover, the British Museum has a specimen of *Ph'naias minor* from Lake Elmenteita, presented by Gregory at about this date.

Bezdek (1946, p. 379) suggested that *Ph. antiquorum* might be eating 'cyanophytic algae' in brackish lagoons in Tunisia, since the water was 'dark green' with these plants; but he admitted that midge larvae (chironomids) and Crustacea were also freely available in these lagoons and gave no evidence from stomach contents as to which the flamingoes were collecting.

Domergue's (1949, p. 122) statement is more difficult to explain, since he found *Ph. antiquorum* feeding in the very salt waters of Rass el Oued Chott in Tunisia, when this supported a bloom of 'green algae only'. He claimed to find no trace of animals there, but since he examined no stomach contents his evidence is only presumptive. Possibly, like the writer, his attention was focused on the plankton, and he may have failed to realize that the chironomids in the mud were sufficiently abundant to feed the flamingoes in Tunisia, as they do in Kenya.

(b) *Food of Phoenicopterus antiquorum in captivity.* Evidence from birds in captivity makes it clear that the diet certainly need not be restricted either to animal matter or to seeds or algae. In the Zoological Gardens of London and Clifton this species survives for years on bread and water, with or without the addition of chopped liver, shrimps or *Daphnia*. At least one specimen at Clifton survived the war years (1939–45) without being given any liver and with only occasional *Daphnia*, and eventually died only from an accident. Wandnagel (cited by Madon 1932, p. 38) found they thrive in Basle on maize, broken rice and green stuff, with some naturally occurring *Gammarus*; but he gives no dimensions of the specimens eaten. In London I saw some *Ph. antiquorum* fishing whole shrimps, about 50 mm long, out of a bucket, in which they were mixed with bread and water; but despite the large size of the bill, the birds were unsuccessful in breaking up the shrimps or swallowing them whole. This last observation confirms the rather small upper size limit of about 10 mm for organisms that can conveniently be collected and swallowed by this species of flamingo. One of the keepers thought that it might be imposed by the small size of their gullets, and this may well be a further factor tending to control the size of their food. The lower size limit for the food is not so clear, but, from the evidence discussed above, it seems to be about 1 to 2 mm.

(c) *Mud as food for Phoenicopterus antiquorum.* The examination of stomach contents has led many authors to claim that when the larger food material either falls short or fails altogether, *Ph. antiquorum* is able to survive on mud with a high organic content. This is not a 'novel opinion' produced only by Gallet (Yeates 1950, p. 198); but was propounded at least sixty years ago by Gadow (1893, p. 150) when he found nothing but mud, rich in the remains of diatoms and algae, in the stomachs of freshly killed specimens and concluded that 'die Nahrung der Flamingos . . . besteht nämlich aus dem schwarzen feinen Schlamm auf dem Grunde stehender Gewässer'. He added specifically that it contained no larger animal remains.

Madon (1932, p. 39), also considered that the animal and plant remains referred to above (p. 454) were so scanty that the mud must have been contributing appreciably to the birds' nourishment.

Gallet (1949, pp. 43, 115 and 116) writes that his autopsies on birds from the Camargue confirmed Madon's observations and revealed the presence of abundant mud in the crop and the whole alimentary tract; but that he could find no trace of animal remains, so that this mud could not have been imbibed within the guts of other animals, such as chironomid larvae. Microscopic examination also showed the extreme rarity of seeds in the mud towards the end of the dry season, when these observations were made. According to Gallet's account the mud had by then become saturated with salts to the point of crystallization; even the *Artemisia* died, and all birds, other than flamingoes, deserted the lagoons for lack of nourishment. Yet in these conditions an entire colony of flamingoes was able to subsist, grow fat and even to bring up their young successfully. Although analysis of mud direct from the lagoons did not show a higher proportion of organic matter than 8%, the fine mud, which the flamingoes swallowed, must have been considerably richer than this, since they leave behind a large amount of residue in the central cones which mark their feeding places. Recent observations on *Ph. ruber* fully confirm the view that the Greater Flamingoes can survive, and that the young can grow, on a diet of mud rich in organic matter (p. 457). On the other hand, Gallet's (1949, p. 116) conclusion that mud is,

therefore, an *essential* component of their diet hardly seems justified, in view of the evidence presented above for their feeding on a variety of small organisms at other times and places. In fact, even Gallet admits that the birds do not reject whole organisms, when these are available! There are unfortunately no published data on the sizes of the material collected and rejected, when the birds are feeding on mud.

*The food of Phoenicopterus ruber*

At one time, American authors seemed convinced that, despite the rarity of a 'monophagous' diet among birds, this species fed exclusively on the small, brackish-water gastropod, *Cerithium* spp. Klingel (1942, p. 162), in his colloquial style, even went so far as to say 'Flamingos and cerithiums are synonymous' (*sic*) and that, 'without cerithiums flamingos would probably cease to exist, their anatomy is [so] specialized for the sifting of these shells from the silt of the lake bottoms'.

*Cerithium* is closely similar to *Tympanotomus* and even to *Paludestrina*; all three are proso-branch genera, occurring in similar situations and abundance, but *Paludestrina* is the smallest. The American *Cerithium* is stated by Zahl (1952, p. 34) to reach 25 mm in height, which is much taller than any European species. Since, however, the shape of the shell is a long thin spire, similar to that of *Tympanotomus*, the maximum breadth would probably still not exceed 5 mm. Apart from other immature molluscs and occasional Crustacea (see below), few other organisms seem to have been recorded as food for *Ph. ruber* under natural conditions.

In captivity, Watts (1941, p. 65) recommends 'cooked shrimp meal, cooked fine rice, special mash and cod liver oil...reduced to a semi-liquid condition'. Rice-grains are smaller than *Cerithium* shells, and probably no harder than other seeds, so the reason for cooking them may have been to achieve a better admixture of other ingredients, rather than making the rice itself more edible.

Recently, Zahl (1953, pp. 183–206) has stated that at least the young birds can survive on organic mud, as do those of the related species in Europe. He describes observations on a healthy flock of about 1000 birds, too young to fly and therefore unable to leave the brackish lagoon on Inagua, where he found them. He strained a large quantity of the mud from the bottom of the lagoon where they were constantly feeding, but found not a single *Cerithium*. He concluded that 'the birds were gulping mud (which)...contained nutrient organic materials, probably of bacterial origin'. In amplification of this, Dr Robert P. Allen, of the Audubon Society, wrote in a letter to Mr Ridley in April 1954: 'Our West Indian bird, (*Ph. ruber*)...has been found in our studies to take quantities of organic slime or ooze containing fair amounts of blue-green algae of at least 8 varieties (*Chroococcus* sp.; *Oscillatoria* sp.; *Gleotheca* sp.; *Spirulina* sp.; *Microcoleus* sp.; *Gleocapsa* sp.; *Lyngbya* sp.; and *Arthrospira* sp.;)...two of these are of the same genus as the algae taken in Elmenteita. Our feeding sites studied in detail are on Inagua Island, Bahamas and, to a lesser extent, a site on the north coast of Cuba... Quite unlike conditions reported by Gallet for the Camargue, we have analysed mud with an organic content that may exceed 90% of the total volume by weight... Most of the organisms in the mud are bacteria, especially sulfur red types. Diatoms were less numerous than blue-green algae. Protozoans include several Foraminifera and Ciliata. Other items were microscopic, immature molluscs, Ostracoda, Copepoda and some Nematoda' (cf. Allen 1956).

*The food of Phoenicopterus chilensis*

It must have been this species which Darwin (1860, p. 66) observed in Patagonia, feeding in a salt lake 'probably [on] the worms which burrow in the mud'. Philippi (1888, p. 160) gives *Nostoc* sp. as the food of this species without stating the evidence; but Sclater & Hudson (1889, p. 118) seem to confirm some such food with their observation of stomachs filled with a 'pulpy mass of greenish coloured stuff'. Wetmore (1926, p. 67) recorded this

TABLE 10. FOOD OF FLAMINGOES WITH SHALLOW-KEELED BILLS

type of animal food	size range in millimetres		species		
	from	to	<i>Ph. ant.</i>	<i>Ph. rub.</i>	<i>Ph. chil.</i>
Oligochaeta	'worms'	—	—	—	—
	<i>Tubifex</i> spp.	0.5 × 20	0.8 × 35	+	—
Nematoda	'very small'	—	—	'in mud'	—
Gastropoda	<i>Paludestrina</i> spp.	1.5 × 4	—	++	—
	<i>Tympanotomus</i> sp.	1.0 × 2.0	3.0 × 12	++	—
	<i>Cerithium</i> spp.	—	ca. 5.0 × 25	—	++
	'snails'	—	—	+	—
	'molluscs'	—	—	—	—
Crustacea	<i>Artemia</i> sp.	3.0 × 20	—	+	?
	<i>Paradiaptomus</i> sp.	ca. 1.0 × 3.0	1.5 × 4.0	+	—
	Cladocera	ca. 1.0 × 1.0	2.0 × 3.0	+	—
	Entomostraca	ca. 1.0 × 1.0	ca. 3.0 × 20.0	—	+ in mud
	'shrimps'	—	—	+	—
Insecta	corixids	ca. 1.5 × 3.0	—	+	—
	chironomid larv:	0.8 × 4.0	2.0 × 10.0	++	—
	'water insects'	—	—	+	—
type of plant food					
higher plants	'aquatic plants'	—	—	—	+
	'vegetable matter'	—	—	+	—
	<i>Cyperus</i> seeds	3.5	4.0	+	—
	<i>Medicago</i> seeds	—	—	+	—
	<i>Juncus</i> seeds	2.0	3.0	+	—
	<i>Leesia</i> seeds	2.0	2.5	+	—
	Papilionaceae seeds	—	—	+	—
Algae	<i>Spirulina</i>	0.03 × 0.1	—	few	in mud
	<i>Nostoc commune</i>	—	—	—	+
	green algae	—	—	?	++
Diatomaceae	'diatoms'	0.02 × 0.07	—	few	in mud

species from the Province of Buenos Aires in 1920, feeding in a canal and 'in the heavily alkaline waters of Lake Epiquen', where 'a form of brine shrimp (genus *Artemia*) swarmed'; but he only surmised that it 'may have formed the food' of this species. In 1940 Housse (1945, p. 74) found this species on Salar del Huasco, a salt lagoon in Chile, and examined the gut contents from two specimens; he states that the food was composed of 'annelids, Crustacea, molluscs and aquatic plants'. This could cover precisely the same food as that taken by *Ph. antiquorum*, or there might be big differences; but, as the lamellae in the two species are so closely alike, a difference in size of food does not seem likely.

The food given to this species in captivity in England seems to be the same as that given to *Ph. antiquorum* (p. 456).

10.2. Food of flamingoes with deep-keeled bills

The food of *Phoeniconaias minor*

The stomachs of two specimens, shot when feeding on the highly alkaline Lake Nakuru in Kenya in 1929, were packed with broken filaments of small blue-green algae, especially *Spirulina platensis* (Nordst.) Geitl.,\* which was forming a dense 'water-bloom' in the lake at that time. This statement is based on my own observations made on the fresh material (Jenkin 1929, p. 574) and confirmed on preserved samples by Rich (1932, pp. 234 and 235), who reported that 'the gizzard contents were found to consist almost exclusively of *Arthrospira platensis*. In the [preserved] gizzards...short lengths and disarticulated fragments...were observed'. I also saw this flamingo in 1929 feeding in large numbers on Lake Elmenteita, where there was also a dense growth of the same alga. The trichomes, or filaments, of this alga are only about 0.008 mm wide, but they are all spirally coiled so that their effective diameter, as far as filtration is concerned, is between 0.03 and 0.06 mm. The length varies from 0.1 to 0.8 mm (figure 14c).†

TABLE 11. FOOD OF FLAMINGOES WITH DEEP-KEELED BILLS

type of animal food		size range in millimetres		species		
		from	to	<i>Ph'n min.</i>	<i>Ph'p. and.</i>	<i>Ph'p. j.</i>
Gastropoda	<i>Paludina</i>	—	—	—	'small'	—
Crustacea	Cladocera	ca. 1.0 × 1.0	2.0 × 3.0	—	+	—
	<i>Emerita</i>	7.0 × 10.0	22.0 × 27.0	—	+ (juv.?)	—
Insecta	libellulids	—	—	—	?	—
	*chironomid larv:	ca. 0.8 × 4.0	—	rare	—	—
	*corixids	1.5 × 3.0	—	rare	—	—
type of plant food						
higher plants	* <i>Cyperus</i> seeds	3.5	4.0	rare	—	—
Algae	<i>Spirulina</i>	0.03 × 0.1	0.04 × 0.8	++	—	—
	<i>Nostoc commune</i>	—	—	—	+	?
	<i>Ulva</i> sp.	—	—	—	+	?
Diatomaceae	<i>Navicula</i> sp.	(0.007 × 0.02)	0.02 × 0.07	++	—	—

\* Taken only by single birds unable to fly, not by members of large flocks.

The results of examining the stomach contents of eight other specimens of *Ph'naias minor* shot while feeding on Lake Nakuru in 1934 (p. 408), have not previously been published. In five, very small diatoms, *Navicula* spp. are present in varying amounts, mixed with remains of algae; but in two stomachs, apart from sand, there seems to be only a dense mass of diatoms. There are no recognizable remains of food in the much contracted eighth stomach. The size of the frustules from the stomach is very constant in each of the samples examined. In one stomach the size of almost all the *Navicula* frustules is about 0.015 × 0.02 × 0.07 mm (figure 14d). These probably belong to a benthic species. In two other stomachs a much smaller *Navicula* species (ca. 0.007 × 0.02 mm) is dominant; but this probably occurs in chains, so that the dimensions of the individual frustules are not of

\* This seems to be the correct name for the species, which was recorded by Rich (1932, p. 234) as *Arthrospira platensis* Nordst. Gomont. (cf. Geitler 1932, p. 925).

† The magnification given by Rich (1932, figure 4) as × 370 must, I think, have been applicable to her original drawings, and should have been reduced by a half for the published figure. P. M. J.

importance for filtration. According to Rich (1932, p. 250) species of these sizes occurred in Naivasha. This use of diatoms for food confirmed my early, if rash, prediction (Jenkin 1929, p. 574) that birds which could collect the algae might also collect diatoms.

Ridley (1954, p. 7) has recently collected thirty-one more specimens of *Ph'naias minor* from different lakes in Kenya, including Hannington. Percy (Ridley *et al.* 1955, p. 157) has made a detailed examination of the stomach contents of twenty-two of them; nearly all confirm the collection of blue-green algae, or diatoms, or both. Only six birds had no algae in their stomachs, and four of these were collected on Lake Naivasha, where the water is not alkaline enough for *Spirulina* to flourish, but provides plenty of diatoms. The other two birds, collected from Elmenteita in November 1951, were the only birds to have eaten neither algae nor diatoms; significantly, both these birds were unable to fly, and came from some half dozen damaged specimens, that were the only *Ph'naias minor* to be seen on the lake at that time. There was then no 'water-bloom' of algae in the lake, and the birds were keeping themselves alive on seeds, chironomid larvae and corixids, like *Ph. antiquorum* which was there in quantity. The algae reappeared next year, and some 10 000 *Ph'naias minor* had flown back to the lake by December; Ridley & Percy (1953, p. 109) then found that the stomachs from four specimens of this group were packed with the blue-green algae. Taking all these records together, it appears that, out of over forty specimens examined from six East African Lakes, twenty-two had definitely eaten blue-green algae, fourteen had taken diatoms with or without algae, and another ten 'confirmed' this. Only the two damaged birds had taken seeds, and only one of these had collected a few chironomids and corixids. That is to say, all the specimens that were representatives of large flocks had been feeding on one or other form of phytoplankton, and it may, therefore, fairly be claimed that these very small plants are the normal diet of *Ph'naias minor*.

There is no other published evidence that I have found on the food of this species, based on examination of stomach contents, since Hume (1872, p. 33) recorded a 'greenish watery substance' in specimens from India. Jackson (1938, p. 93) confirms that, in East Africa, 'occasional specimens' have been recorded from Lake Naivasha, where, as we have seen, they can obtain diatoms; and that large flocks find 'a particular and more abundant food supply' in the 'brackish lakes which this species favours', referring, we may assume, to the algae discussed above.

#### *The food of Phoenicoparrus andinus*

The first published statement on this appears to be that of Philippi (1855, p. 10), in German, which may be translated as: 'they fished in mud [of lagoons] . . . for libellulids, water-fleas, and small *Paludina*' (*sic*).<sup>\*</sup> In 1888 (p. 160) he gives the main food as '*Nostoc commune* and *Uloa*' (*sic*).<sup>†</sup> In Philippi's later (1902, p. 74) description of *Ph'parrus andinus*, food is not mentioned. Walcott (1925, p. 357) claimed that *Ph'parrus andinus*, on Laguna Colorada, was feeding on small crustaceans, which gave a brick-red colour to the alkaline lake; but, unfortunately, he did not identify the Crustacea, nor apparently examine any of the stomach contents. Murphy (1936, p. 40) reports that the well-filled stomach of a single specimen, from a group of about forty 'Andean Flamingoes' feeding on the coast of Peru, contained sand-crabs (*Emerita analoga*). Even though their shell is relatively soft,

<sup>\*</sup> = *Paludestrina* ? P.M.J.

<sup>†</sup> = *Ulva* ? P.M.J.



adult sand-crabs (table 11) certainly seem to be too large for any flamingo to eat; but there were probably enough immature specimens in the population to satisfy the needs of this small flock of birds.

*The food of Ph'parrus jamesi*

Some obscurity and contradiction seems to surround this topic. Rahmer, who collected specimens of this species in the Andes, refers to it, first in Spanish (1886, p. 754) and then, almost word for word, in German (1887, p. 161), which may be translated literally, as 'resembling *Ph'parrus andinus* in behaviour and way of life, and in feeding itself, like this species, on hair-like algae...in very shallow, salt lagoons'. Moreover, this statement is made yet again in Spanish, in the same words, by Philippi (1902, p. 75) in the course of a fuller description of *Ph'parrus jamesi*; but he gives no reference to the source of this statement, nor does he comment on his own previous accounts of the food of the other species as consisting of either such large organisms as libellulids and molluscs, or '*Nostoc commune*' which, though a filamentous alga, may form a gelatinous mass. The algae, which would have been classified as *Ulva* at that date, all have a rather broad thallus and are also not 'hair-like'; but Dr M. W. Parke made the interesting suggestion (personal communication) that the birds may have been eating the spores which these algae frequently produce in large quantities. No other reference to the subject has been traced.

It can only be emphasized that the distribution of *Ph'parrus jamesi*, like that of *Ph'naias minor*, is in and around high-altitude salt lakes that may also be alkaline, and that these provide a habitat more likely to favour the growth of algae (especially blue-green algae) than arthropods and molluscs. Small filamentous algae or spores would certainly seem better suited than molluscs to the thin and delicate upper jaw of *Ph'parrus jamesi*, and to its fringed inner platelets, so remarkably similar to those of *Ph'naias minor*.

## 11. SIZE OF GRIT COLLECTED IN THE GIZZARD

Flamingoes, like many other birds, collect and swallow hard particles of grit, which are used to triturate the food when it passes from the glandular proventriculus into the muscular part of the stomach, or gizzard.

The size range of the grit is found to be distinctly different in the two species of flamingoes in Kenya and is comparable with the size of their food in each case. This may be taken as evidence in favour of the grit being collected in the same way as the food, though an alternative explanation will be discussed below.

Ridley & Percy (1953, p. 110 and figure 2) have analyzed the sizes of the mineral particles in the stomachs of both *Ph. antiquorum* and *Ph'naias minor* from Elmenteita, using British Standard Sieves which retain particles of:

over 1.7	mm on sieve with reference number	10
over 0.5	mm on sieve with reference number	30
over 0.25	mm on sieve with reference number	60
over 0.16	mm on sieve with reference number	90
over 0.15	mm on sieve with reference number	100
over 0.125	mm on sieve with reference number	120

They separate the particles into sizes ranging from that of one sieve to that of the next. Results, expressed as percentages by weight, have been averaged for a number of birds for each year group in tables 12 and 13.

The size range of particles collected by different specimens of *Ph. antiquorum* at any given time is relatively uniform, but differs somewhat from one time to another (table 12). Although at least 80 % of all the grit collected in 1951 is over 0.5 mm, almost all the stones are under 4 mm. Only a few reach 5 mm, even in one dimension, and these are all very thin; only one from Elmenteita measured as much as 5.8 mm. Samples, kindly lent by Colonel Meinertzhagen, from Port Sudan and Somaliland, were similar, except that a sample from two birds contained two stones as large as  $7 \times 3 \times 2$  mm. The gastropods (p. 455) collected by these two birds were also larger than in the other samples from the same region.

TABLE 12. ANALYSES OF GRIT COLLECTED BY *PHOENICOPTERUS ANTIQUORUM*

reference number ...	—	British Standard Sieves					100	...	total
		10	30	60	...	100			
size (mm) ...	5 to 4	1.7	0.5	0.25	—	0.15	—	5 to 0.15	
1951, 3 birds	2	37	58.5	2	—	0.5	—	100	
1952, 2 birds	?	37	43.0	12	—	8.0	—	100	

TABLE 13. ANALYSES OF GRIT COLLECTED BY *PHOENICONAIAS MINOR*

reference number ...	—	British Standard Sieves						total
		10	30	60	90	100	120	
size (mm) ...	5 to 4	1.7	0.5	0.25	0.16	0.15	0.13	4 to 0.13
1934, 3 birds*	0	0	6	81.5	9	—	3.5	100
1952, 4 birds	0	0.5	17	64	—	18.5	—	100
1951, 2 birds†	0	1‡	36.5	53	—	9.5	—	100

\* P.M.J. measurements.

† Isolated birds feeding on seeds, etc.

‡ Most less than 3 mm in greatest dimension and thin enough to pass between marginal platelets.

Therefore there seems to be a fairly well-defined upper size limit of about 5 mm for the grit collected by this species of flamingo, though this may vary somewhat with the size of the food that is being taken. There is also a lower limit near 0.1 or 0.2 mm, although the bulk is over 0.5 mm. The fine particles retained by the 0.15 mm sieve mesh may have been produced by attrition within the gizzard.

The size of grit collected by *Ph'naias minor* is shown in table 13; the figures for 1952 based on Ridley & Percy's histograms (1953); those for 1951 and 1934 extended by direct observation. The groups for 1934 and 1952 represent large flocks feeding normally on algae, and show well over 80 % of the particles to be less than 0.5 mm in length. The 1951 group represents the damaged birds feeding on an abnormal diet of seeds, etc., and the proportion of fine grit drops to 62.5 % and larger particles are slightly increased. This change may be accounted for by assuming that the birds must have opened their bills wider for collecting seeds than algae. Nevertheless, although these birds were feeding on the same size of food as *Ph. antiquorum*, the proportion of large grit particles that they collected is still significantly lower than in the larger flamingoes (table 12); the maximum size of particles is also distinctly smaller than in *Ph. antiquorum*, there being very few over 3 mm and none over

4 mm. In the 1934 group there are no particles over 1.7 mm. In contrast to *Ph. antiquorum*, all groups of *Ph'naias minor* have 9.5 to 18.5 % of grains that pass through the 0.25 mm sieve.

There are two possible explanations of these marked differences. One is that *Ph. antiquorum*, which fishes in the mud on the lake bottom (p. 451), has access to larger and heavier particles than *Ph'naias minor*, which fishes near the surface of the water, whence the larger particles would sink out of reach by gravity; but even when feeding on the bottom, *Ph'naias minor* (1951, table 13) still collects smaller particles than the other species (table 12). The other possible explanation is that both species collect grit for the gizzard from the same source, as they feed side by side in the lake, and that in both cases the range of particle size collected is determined by the structure and use of the bill. The latter seems the more plausible for various reasons. It is hard to imagine that in both Elmenteita and Port Sudan the feeding places of the flamingoes have no stones larger than 7 mm, rather than seeing evidence for *Ph. antiquorum* having some means of excluding larger stones. The smaller maximum size for particles collected by *Ph'naias minor* could be similarly determined by a finer mesh of excluder. Even if the latter species did not have access to the larger particles, it is difficult to see how it could retain more small particles than *Ph. antiquorum*, unless it were provided with, and used, a finer mesh of retaining filter. If the 'jig' movement (p. 451) stirs up sand grains into suspension, and the larger particles sink again by gravity before they can be collected with the food, the process could hardly produce different-sized grains for the two species. However this may be, it will appear in the next section (§ 12) that the fairly close agreement between the size of grit collected and the size of the food taken by the two species of flamingoes can be related to the sizes of their lamellar structures.

There is no available information on the size of grit collected by the other species of flamingoes, in either group.

#### DEDUCTIONS

##### 12. IDENTIFICATION OF STRUCTURES USED FOR FILTRATION OF FOOD AND GRIT FROM THE WATER AND FOR EXCLUSION OF LARGER PARTICLES DURING FEEDING

Since there is no direct evidence as to how the flamingoes achieve their filter-feeding, recourse must be had to deductions in order to reconstruct the process as nearly as possible. The basis adopted here is to try and identify the parts of the bill used for filtration and exclusion, by comparing the sizes of grit and food particles collected with the sizes of the various structures in the bill; and then to relate these to the known movements of the bill, in order to postulate the process of filtration in different cases.

Grit provides the most useful data for identifying the filter and excluder in *Phoenicopterus*, since it has been analyzed by sieves which give direct values for the size of filters needed to collect the whole, or a known proportion of it. The only uncertainty is the rate at which the grit is worn down by attrition in the gizzard, whereby the larger particles indicating excluder size may become too small, and the fine residue produced may suggest too small a size for the filters. It is, however, assumed that the process is slow and virtually negligible as the gizzard has muscles which, though stronger than those of most ciconiids (Gadow 1891, p. 617 and 1893, p. 150), are poorly developed compared with those of grain-eating birds. Diatoms from the gizzard afford the best data for identifying the filters in *Phoenico-*

*naias*, indicating by direct measurement a much smaller size than the finest grit in the sievings; they also confirm that little change in form occurs in the gizzard.

Knowing the grit or diatom size, the bill structures can be reviewed to see which could provide filters of the required mesh in a suitable position; and the same can be done for the excluders. Food sizes, which are usually less exact than those of grit and diatoms, can then be used to confirm the postulated filters and excluders.

Although this procedure is theoretically possible, it is not quite so simple in practice, because of the variations in shape of all the items involved. Few of the objects to be collected are spherical, and few of the spaces that might act as filters are isometric, even if they are rectangular; they grade in size from one part of the bill to another. A search can, nevertheless, be made through the lamellar systems for spaces of the right order of magnitude, taking into account their orientation in relation to possible water currents through the bill.

In identifying **filters** it must be noted that some of the pieces of grit and many of the food organisms are cylindrical or oblong, with one dimension much greater than the others; but it is probably true that in a random sample of such objects only a very small proportion would hit a filter so exactly end-on as to pass through a mesh that was just larger than their diameter but smaller than their length. The proportion that would be so lost would be negligible for a bird feeding in an abundant supply of such objects. We may therefore assume that a sufficiently high proportion of the available food will be collected if the dimensions of the filter, in the filtering plane, are *less than the diameter* of spherical objects or *less than the length* of cylindrical objects collected.

Since it is possible that a small proportion of particles, smaller in size than the average mesh of the filter, might be collected if the filter became clogged, or be produced by attrition of the grit, it is not necessary to insist that the filter must be finer than the finest particles found in the stomach. Conversely, some large stones may find their way into the bill end-on by virtue of their smaller dimensions; therefore the **excluder** need not necessarily have spaces commensurate with the largest dimensions of the largest particles found in the stomach.

#### 12.1. *Filters and excluders in shallow-keeled bills*

##### *The filter of Phoenicopterus antiquorum*

The analysis of grit sizes for this species (table 12, p. 462) show that a sieve of 0.15 mm mesh would collect 100%, and one of 0.25 mm at least 90% of the particles found in the stomach. Following the line of argument set out above we must therefore look for filter-forming structures with spaces of about 0.25 mm in either dimension.

Taking the lamellae in order (§ 6.1), the sizes of the spaces that might form the filter can now be considered. The inner lamellae of the lower jaw are ridges with channels between them (*il-th*) measuring 0.1 to 0.16 mm across (table 4, p. 428); and the inner lamellae of the upper jaw are ridges or platelets with spaces (*il-th*) measuring 0.07 to 0.15 mm. Both these are too small. The platelets on the upper jaw form diagonal rows which leave channels (*ir*) about 0.5 to 1.0 mm across, and these would be rather large. Moreover, all these channels have only three sides and are open on the fourth to the cavity of the mouth, which is kept slightly open by the tucking in of the outer hooks into the gape. As a result, the jaws are kept about 1.5 mm apart, while the maximum height of

the upper lamellae is 0.43 mm and of the lower is only 0.23 mm, so that there is plenty of space for objects of as much as 0.7 mm in diameter to be washed about inside the bill without even touching the tips of the lamellae, which therefore seem unfitted to form any part of the filter itself.

The outer lamellae of the lower jaw are low serrated ridges with channels between them (*il-th*, table 5, p. 430) measuring 0.2 mm across proximally and increasing to 0.5 mm distally. These measurements come within the required range; but again these channels are open above and cannot act alone as a filter. The **marginal outer lamellae of the upper jaw** form the large leaflets proximally and hooks distally which have always been supposed to form the filter; but their measurements are all too large, for the channels between them (*il-th*, table 5) range from 0.4 mm across proximally to 1.43 mm distally. They are indeed closed channels, for the tips of the platelets touch the lower jaw, but their heights (*h*) range from 0.73 to 1.5 mm.

Since none of the sets of lamellae taken alone can form a filter of the required mesh, the answer must be sought in a combination. The **submarginal platelets of the upper jaw** (figures 8*a* and *b* and 9) subdivide the gaps between the bases of the marginal platelets. The spaces between them range from 0.23 to 0.41 mm across (*il-th* submarginal, table 5, p. 430), which is just the measurement required by our theory; but they are not the whole answer, since they are not high enough. Their height is everywhere from 0.4 to 1.75 mm less than that of the marginals, which determine the width of the gape (*g.*, figure 18*a* and *c*). But it is here that taking the **lower outer lamellae** (Ss) into the combination subdivides the wide spaces between the tips of the marginals (Pks and Pls), in the same way as is done by the submarginals (*s.m.*), at their base. The channels between the lower outer lamellae are of the right width, and their height, though less than that of the submarginals and not enough to let them meet the latter across the gape except at D (figure 18*a*), yet brings them at most points along the bill within less than 0.6 mm of the others. The combined effect of these structures is to build up a double fence, rather than a net, across the gape, in order to form the effective filter. The shape of the mesh is somewhat irregular; but the following figures show that the spaces usually have at least one dimension less than 0.5 mm. Only at F does the minimum increase to 1.03 mm:

position on bill	...	AN		BN		B		D		F	
		<i>h</i>	<i>il-th</i>	<i>h</i>	<i>il-th</i>	<i>h</i>	<i>il-th</i>	<i>h</i>	<i>il-th</i>	<i>h</i>	<i>il-th</i>
measurement	...										
marginal lamellae		0.73	0.46	1.8	0.43	1.9	0.76	1.5	1.43	2.2	1.03
submarginal lamellae		0.33	0.23	1.0	0.36	1.0	0.2	0.8	0.41	0.43	0.38
lower outer lamellae		0.2	0.2	0.2	0.23	0.5	0.46	0.8	0.5	0.5	0.4
space between submarginal and lower lamellae		0.2	—	0.6	—	0.4	—	0.0	—	1.27	—

The **filter** size thus ranges from about 0.2 × 0.4 to 1.0 × 1.3 mm.

The action of this filter was tested by filling a fixed bill with a suspension of fine gravel (0.25 to 0.5 mm sample from the sieves) and then trying to wash it out; some of the finest came out, but a number of grains became so wedged between the proximal outer lamellae, where the space is 0.4 mm by measurement, as to be quite difficult to dislodge with a jet of water. Distally the filter must depend more upon the submarginals and the outer lamellae of the lower jaw, than on the widely set marginals, to maintain its fine mesh.

Table 10 (p.458) shows that the minimum size indicated by the food of *Ph. antiquorum*, when it is feeding on solid objects, is 0.5 mm in the case of *Tubifex*, and over 1.0 mm for most of the other organisms. Although these figures are less exact than those derived from the grit, they are all rather larger. A filter identified by being commensurate with, or even slightly larger than, the smallest grit particles would, therefore, catch the food. The size of the food thus confirms the identification of the filter proposed above. The filter differs from that previously assumed, by having the spaces between the upper hooks and leaflets subdivided by the submarginals and lower outer lamellae (figure 18*a*). The only exceptions to the statement about the size of food are provided by the occasional algae and diatoms which are collected by *Ph. antiquorum* when it is feeding upon mud. There are no measurements of grit found in the stomach when the birds are reduced to this diet; but since the usual process of filtration is unsuited to its collection (§ 13.2), the sizes of the algae do not invalidate the evidence given above for identifying the normal filter.

#### *The excluder of Phoenicopterus antiquorum*

At least 98 % of the grit analyzed in table 12 is less than 4 mm, and of those pieces which reach 7 mm in one dimension, it was noted that their other dimensions were considerably less. The excluder must therefore have spaces approaching 4 mm; but there are clearly no such spaces between any of the lamellae, and exclusion must presumably be achieved by the controlled opening of the gape itself.

The measurements of the food (table 10) show that the kinds collected never have more than one of their dimensions over 4 mm, which agrees with the size of the grit. Even such large organisms as *Tympanotomus*, with a length of 12 mm, are less than 4 mm across at the base of the spire and so can enter the beak as it were on their sides; though it is more than possible that the bill may be opened slightly more widely when the birds are feeding on these shells than it needs to be when, for instance, they are feeding on chironomids.

This amounts to postulating an adjustable **excluder** of about 4 to 10 mm for *Ph. antiquorum*, formed by the extent to which the bill is opened to allow the intake of food (figure 18*b*). For any given angle of opening, the width of the gape will increase from the base to the bend of the bill; but for other reasons it is probable that most of the food is taken in beyond the bend in the bill. The bend itself causes the displacement of the upper jaw, relative to the lower, to be more like drawing the one along the other than raising it away from it, as it would be if the bill were straight and the upper jaw were rotated about A (figure 1). The bending down of the tip of the bill thus reduces the extent of the separation of T from T' for any given angle of opening, as compared with a straight bill. Inspection of the outer lamellae shows that they increase in height from C to F; they thereby help to counteract the increasing width of the gape between these points when the bill is opened, and maintain a rather more nearly uniform size of excluder. When the gape at B is 4 mm across, at T it is about 10 mm.

#### *The filters and excluders of Phoenicopterus ruber and Ph. chilensis*

In these species it is clear that the form and measurements of the lamellae and bill are so similar to those of *Ph. antiquorum* as to allow of their filters and excluders being almost

certainly the same. Only one point calls for comment. The upper marginals of *Ph. ruber* curl inwards so much distally that their vertical height is reduced to 0.5 mm or less, from D to F; this will permit the gape to be more nearly closed than it can be in *Ph. antiquorum*, and will bring the inner lamellae of the two jaws nearer together, allowing them to be of more use in *Ph. ruber* than in the former species. The submarginals have not been measured in *Ph. ruber*; but it might be expected that while serving to subdivide the spaces between

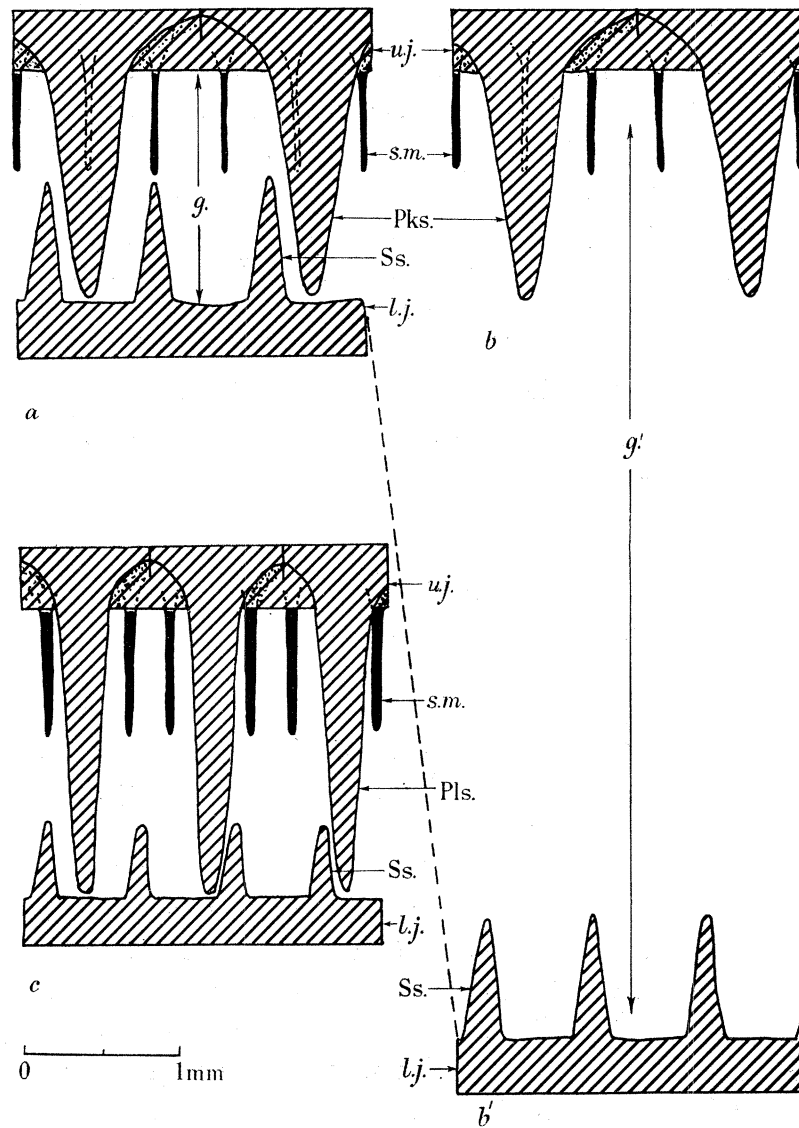

FIGURE 18. *Ph. antiquorum*. Diagrams to show the postulated filter and excluder, looking at the gape from outside the bill. (a) The filter formed by outer lamellae at D (figure 1), when the jaws are closed and the gape,  $g$ , is completely crossed by the marginal hooks, Pks, on the upper jaw,  $u.j.$ , and by the combined height of upper submarginals,  $s.m.$ , and the serrated outer lamellae, Ss, on the lower jaw,  $l.j.$  The outflowing current would come towards the reader. (b) and (b') The excluder at D formed by opening the jaws to a limited extent,  $g'$ , so that objects of more than about 5 mm long cannot pass into the bill with the inflowing current, which would go away from the reader. (c) The filter at B for comparison with 18a. In both, the spaces usually have at least one dimension no greater than 0.5 mm, to form the finest mesh of the filter. Pls, marginal leaflets on the upper jaw.

the marginals to form the filter, as in *Ph. antiquorum*, they will meet the lower outer lamellae across the gape along its whole length, rather than only for a short part of it.

Such data as there are on the food of the two American species do not run counter to the postulate of their filters and excluders being the same as those of *Ph. antiquorum* when feeding on larger organisms.

### 12.2. *Filters and excluders in deep-keeled bills*

#### *The filter of Phoeniconaias minor*

The bulk of the diatoms from the stomachs of the 1934 group passed like a fine dust through the sieve with 0.13 mm mesh, whereas the finest grit was usually retained by the sieve with 0.15 mm mesh (table 13, p. 462). Measurements of the diatoms are therefore of more significance than the grit for determining the necessary size of filter for this flamingo. The diatoms are uniform in size, measuring  $0.02 \times 0.07$  mm (table 11, p. 459); the filter must therefore have spaces not greater than 0.05 mm in either of their dimensions, if a reasonable proportion of the available diatoms is to be collected.

The spaces between the outer lamellae, which form the filter in *Ph. antiquorum*, are here clearly of the wrong order of magnitude altogether (table 8, p. 442). The **inner lamellae of both jaws** form platelets, with spaces (*il-th*) of 0.05 to 0.12 mm, in most parts of the lamellated area; only near the base are they as small as 0.03 mm. The tips of the platelets meet those of the opposite jaw across the gape, to enclose the inter-lamellar channels; but their combined heights may make these spaces as much as 1.0 mm high (table 7, p. 436). These spaces are therefore rather large for the required filter, as are the even wider channels between the diagonal rows of inner platelets, where *ir* is usually about 0.3 mm. (The latter are probably used as intake channels, as they would allow five to ten coils of *Spirulina* abreast to pass along them.)

The only structure in *Ph'naias minor* which provides spaces commensurate with the diatoms is the **fringe** on the platelets. The fibres in the fringe are spaced rather irregularly and their tips diverge; but they also cross one another and overlap to some extent. On an average there is about one fibre every 0.015 mm, and the fibres themselves are 0.005 mm thick; so that the spaces measure about 0.01 mm across, and have a length equal to that of the free fibres in the fringe, or about 0.05 to 0.06 mm. This is just less in each dimension than the diatoms (figures 14 and 19*a*) and should therefore provide an excellent filter; it almost certainly does so, despite a doubt as to the direction taken by the current of water which should be filtered by the fringes. The measurements given are those seen if the platelet is in profile; but in the bill, the platelets are nearly all orientated transversely across the lamellated area, with the thin, fringed edge towards the tongue, and therefore hanging into the space between the diagonal rows (figure 13), where it is far away from the next platelet and could easily be by-passed by a current flowing along the diagonal channels. Only if the current of water passes more or less transversely to the axis of the bill along the lines of the lamellae, does it flow into the 'teeth' of the fringe, to pass through the inter-lamellar spaces. These last are too large for efficient filtration; but the fringes become effective, since they do not remain in the plane of the platelet. In some cases they all appear to bend over one way, so that their fibres touch the blade of the adjacent platelet (figure 26, plate 15). In some isolated groups of platelets it looks as if the fibres of the



fringe diverge to either side of the blade from which they arise, to meet fibres from the fringes of adjacent platelets. In either case they spread their mesh across the inter-lamellar spaces (figure 19a).

The food of *Ph'naias minor* has already been taken into consideration, as far as diatoms are concerned, in identifying the filter. It need only be added that the coils of *Spirulina*, which form the other most usual food of this flamingo, measure about  $0.025 \times 0.1$  mm and would therefore be a trifle larger in proportion to the filter than the diatoms, but still of a size to be easily collected.

It may, therefore, be concluded that the fringes form the **filter** by crossing the inter-lamellar spaces and subdividing them into meshes of about  $0.01 \times 0.05$  mm. The efficiency of this system is certainly increased by the great width of the lamellated area in this species, since this provides not one row of filtering fringes only, but row upon row, up to eighteen or more, between the middle of the bill cavity and its margin (figure 12). Food, which might get through one or even two filters, will certainly be caught by successive rows before it can escape at the gape. It is striking that this filter is formed from the inner and not the outer lamellae, as in *Ph. antiquorum*.

#### *The excluder of Phoeniconaias minor*

Table 13 shows that the size of grit collected by this species rarely reaches large enough dimensions to be retained by the 1.7 mm sieve; normally 80% passes through the 0.5 mm sieve. Only rare stones had one dimension as great as 3 mm, when the birds in question had been eating unusually large food.

It may be assumed from this that the excluder must have spaces that are certainly no larger in either dimension than 2 mm and probably nearer 0.5 mm.

The requisite **excluder** (figure 19b) is probably formed by the **marginal platelets of the upper jaw**, since the spaces between these,  $h \times (il-th)$ , range from about  $0.5 \times 0.4$  to  $1.0 \times 0.6$  mm (marginals, table 8, p. 442). The submarginals do not cut across these spaces as they do in *Ph. antiquorum* (cf. figure 26, plate 15, with figure 30, plate 17), and the spaces between the marginals therefore lead freely into the diagonal channels.

Food organisms even approaching the size of the spaces in the excluder are rare and practically confined to the corixids and chironomids collected by damaged birds (p. 460). The size of *Micronecta jenkiniae* (Hutchinson 1932, p. 327), known to occur in the locality, is about 3 mm long and is of comparable size with the largest pieces of grit. If these objects did not enter the bill end-on, which seems a little improbable, the gape was presumably opened slightly to admit them, as in the case of *Ph. antiquorum*.

#### *The filters and excluders of Phoenicoparrus andinus*

There are no records of grit sizes for this species or the next by which to check the sizes of filters and excluders; but because the structure of the bill and lamellae in both are in many ways so similar to those in *Ph'naias minor*, it seems reasonable to adopt the reverse procedure from that undertaken so far, and to assume that the equivalent structures perform the same functions, and to examine them to see what sizes of filters and excluders they would form.

In *Ph'parrus andinus* the inner platelets, which should form the filters, have no fringes. The thickness of the platelets themselves is rather uncertain, but appears to be about

0.02 to 0.04 mm. The spaces,  $h \times (il-th)$ , between the platelets, which must here form the **filter**, then range (as far as the few measurements on both jaws can show) from  $0.3 \times 0.6$  to  $1.2 \times 0.14$  mm. The smallest objects that would be caught by *Ph'parrus andinus* would be about  $0.5 \times 0.1$  mm, or ten times the linear dimensions of the algae that can be collected by *Ph'naias minor*, but smaller than the dimensions of the smallest organisms collected by *Ph. antiquorum*.

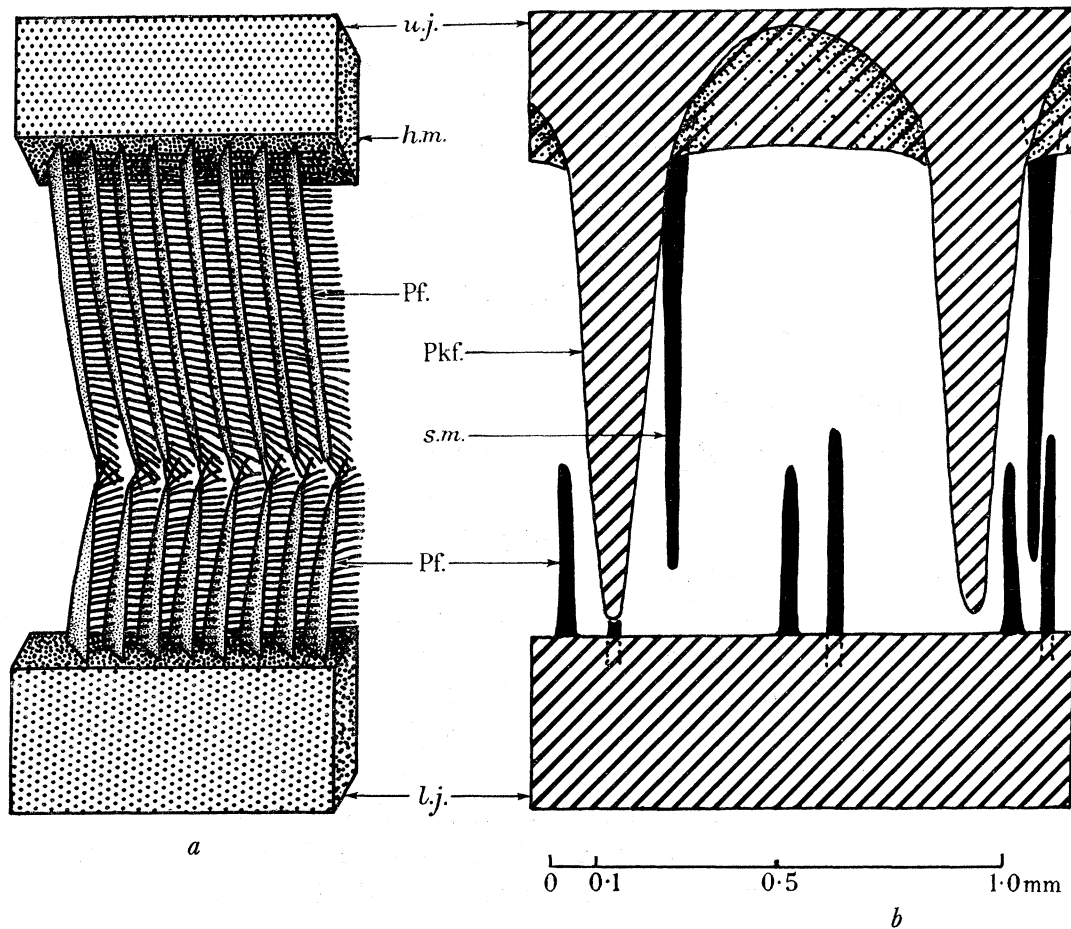

FIGURE 19. *Ph'naias minor*. Diagram, on three times the scale of figure 18, to show the postulated filter and excluder. (a) Part of the *filter* of inner platelets which would face, somewhat obliquely, the most direct outflowing water current, on its way through the right-hand gap from the tongue to the exterior. The orientation of this diagrammatic section of the horn, *h.m.*, on the lamellated area, is such as to include part of a diagonal row of fringed platelets, *Pf.*, on both upper jaw, *u.j.*, and lower jaw, *l.j.* In the bill, this filter is repeated by each diagonal row of platelets (cf. black arrows in figure 12, where the tip of the bill is near the reader and to the right; whereas here it would be near, but to the left, with the gape horizontal). The meshes of the filter measure about 0.01 mm across by 0.05 mm along (see discussion on pp. 475 et seq.). (b) The *excluder*, seen from outside, is comparable with figure 18*a* and *c*; but here the gape is on top of the bill, rather than at the side, and the scale is trebled. The spaces between the marginal hooks, *Pkf.*, measure about  $0.5 \times 1.0$  mm, if the gape is not opened; but, if it were, the pattern would not change at first, as the upper jaw would be raised in a direction at right angles to the plane of the paper. Submarginals, *s.m.*, stand in the diagonal rows and therefore do not affect the size of the excluder (cf. figure 26, plate 15).

If in *Ph'parrus andinus* **excluders** are formed, as in *Phoeniconaias*, from the marginal leaflets and hooks crossing the closed gape, the spaces between them,  $h \times (il-th)$ , would range from  $1.5 \times 0.7$  to  $2.5 \times 1.0$  mm. This should make the excluder effective for objects with smaller dimensions of about 1.0 to 2.5 mm, which is larger than the excluder of *Ph'naias minor*, but one-quarter the dimensions of that of *Ph. antiquorum*.

The food is not sufficiently definitely known to afford any evidence on the size of either filters or excluders.

*The filters and excluders of Phoenicoparrus jamesi*

The inner platelets are fringed, as they are in *Ph'naias minor*, and it may be assumed that they can be used in the same way to form the **filter**. The thickness of the fibres in the fringe is 0.004 mm, and they occur at least every 0.01 mm, leaving spaces about 0.006 mm across, and as high as the fringe, which varies from 0.04 to 0.06 mm. The platelets examined are, however, rather damaged, and in several it has not been possible to clear the fringe completely of debris, so that these measurements are rather uncertain; but a small filtering mesh of about  $0.005 \times 0.05$  mm is indicated. The fringes seem to extend 0.04 mm on either side, beyond the thickness (0.015 mm) of the platelet blades; but this may only be due to damage. They could cross the adjacent inter-lamellar spaces ( $il-th$ , 0.085 mm), as in *Ph'naias minor* (p. 468).

An **excluder** formed from the upper marginals of *Ph'parrus jamesi* would have spaces,  $h \times (il-th)$ , measuring about  $0.6 \times 0.15$  to  $2.5 \times 0.25$  mm, which is rather narrower and longer than the corresponding spaces in *Ph'naias minor*; this might allow the entry of slightly larger objects.

There is no evidence to be had from the food of this species.

There is thus a radical difference of function postulated for the outer lamellae in the two types of bill. In the shallow-keeled bills of the three species of *Phoenicopterus* these form the filter, while the inner lamellae have no clear function; in the deep-keeled bills of *Ph'naias minor* and the two species of *Phoenicoparrus* the evidence all points to the outer lamellae acting as excluders, while the filtration is transferred to the inner lamellae or even to their fringes.

13. RECONSTRUCTION OF THE PROCESSES OF FILTRATION AND THE VARIATIONS THAT MUST BE POSTULATED IN DIFFERENT CIRCUMSTANCES AND SPECIES

In principle, two ways of achieving filter-feeding are possible: one is to force the medium in which food is suspended through a fixed, or but slightly moving, filter; and the other is to sweep the filter through the medium. Both methods have been adopted by a variety of unrelated animals. The first and commoner method is to be seen in the flagellar and ciliary systems of sponges, lamellibranchs and protochordates and also in many Crustacea, including *Cheirocephalus* and *Hemimysis*. The second is found in cirripedes among Crustacea, in *Simulium* larvae among insects, and in the whalebone whales among mammals.

Filter-feeding in flamingoes employs both these methods, since the tongue is used to pump a food-bearing current of water through the filter on the bill; and at the same time the birds also sweep the whole filtering system to and fro through the water, thereby bringing the filter into constantly renewed sources of supply.

Detailed examination of other filtering systems has usually shown them to be highly complex, especially where water currents are involved. It may well be rash to postulate a mechanism which has not been directly observed nor tested with carmine particles, especially when no comparable system has been fully described for any birds. Nevertheless, the attempt will be made, because a good deal of information has now been brought together, and it is difficult to see how complete observations within the bony bill of the living bird could be achieved, even by X-ray observation of a barium meal on very tame specimens.

No other case can be brought to mind in which a filter of *graded* mesh is used; nor has any allowance been made for these gradations in the processes of filtration postulated below. The most plausible suggestion is that they may help any given species to collect a wider range of different sized food than would otherwise be possible.

It appears that the process of filter-feeding in flamingoes cannot be the same for all species, nor even for the same species in different circumstances; but that to be consistent with all the facts, three distinct processes have to be postulated:

- (1) that used by the three species of *Phoenicopterus*, with shallow-keeled bills, when feeding on whole organisms, or seeds;
- (2) that used by *Phoenicopterus* when feeding on mud;
- (3) that used by *Phoeniconaias* and presumably by *Phoenicoparrus*, with deep-keeled bills, when feeding on fine particles, such as diatoms or algae.

#### 13.1. *Process of filtration when Phoenicopterus antiquorum feeds upon whole organisms*

When the inverted bill is swung through the mud or water in which the food occurs, it is often tilted, so that the gape on the leading side is nearest to the substratum, as it scoops the mixture of food and medium into the mouth (§ 9.2). The gape must at the same time be opened widely enough to admit the available food (figure 2); but it is not opened to its full extent, since it is the width of the gape (4 to 10 mm, p. 466 and figure 1) which acts as the excluder, setting the upper size limit to the material collected (figure 18*b*).

Meanwhile the tongue moves rapidly and strenuously backwards and forwards within the trough of the lower jaw. It moves sharply backwards while the gape is open, to suck in food as well as water and the surrounding mud (figure 2). It then shoots forward again, while the upper jaw is lowered to close the gape as nearly as its marginal hooks will allow. What remains of the gape is then crossed at all points by the filter-forming outer lamellae of the upper and lower jaws. This filter (p. 465 and figure 18*a*) retains the food, while water and all the fine particles of mud and algae, that may have been in the mouth, are squirted out with considerable force (p. 453). The complete movement of the tongue and the accompanying 'champing' movements of the upper jaw are repeated about four times each second, and are quite sufficiently energetic to wash the food free from mud. The tongue can also apparently press against the jaws so as to squeeze most of the moisture from the mouthful before it is swallowed. Gadow (1893, p. 150) says that the birds raise their heads to swallow, as might be expected; but, if so, the movement only occurs between long periods of filtration.

This type of filtration in *Ph. antiquorum* would seem to be almost self-evident and would hardly merit description were it not that previous authors imply that it is the only method

used by flamingoes, and that it is well known. No account, however, has been found to include all the points so far given. For instance, Owen (1832*a*, p. 141) states: 'the horny denticles of the upper mandible and the transverse marginal furrows of the lower mandible form together a filter and, like the plates of whalebone in the Balaenae, allow the superfluous moisture to drain away, while the small . . . animalcula are detained and swallowed'; but this omits the submarginals and makes the process sound much too passive. Chapman (1908, p. 189) recognizes the activity of the process, but, like most other writers, he attributes it solely to the movement of the upper jaw and makes no mention of the tongue.

Moreover, the bill is lined by the complex system of inner lamellae (pp. 426 et seq.), for which no particular function has yet been given. They are not high enough to meet across the gape, even when the jaws are as nearly closed as possible. They cannot, therefore, serve any direct function in filtration, though they may help to grip larger objects while the mud is being washed out. The firm, slightly flexible texture, especially that of the small pointed platelets on the upper jaw (p. 427), would allow them to be deformed by pressure from solid objects in the bill, and to transmit tactile stimuli, as Plate (1922, p. 263) suggests, to the Herbst and Grandry corpuscles, said to be abundant at their base (p. 450). The function of the inner lamellae might then be to 'feel', as well as to hold, any solid objects present in a muddy mouthful. The grass blades, passed through the bill as if for inspection by captive birds (p. 452), were perhaps being tested in this way for adherent animals.

One other feature of the bill of *Ph. antiquorum* may play a part in feeding. In the inverted feeding position the inrolled borders of the lower jaws (cf. figures 21 and 22, plate 14 and *i.b.*, figure 4*c*) form a gutter facing upwards on either side of the tongue. Testing a bill with a mixture of gravel and water shows at once how the pieces retained by the filter tend to collect by gravity in these gutters. Presumably from there they can be licked up by the tongue, when enough have accumulated to be worth swallowing. The peculiar recurved spines on the tongue (figures 1 and 17*a*) undoubtedly help both to collect the food from the filter, their relation to which can best be seen in the section (figure 21, plate 14), and 'to rake the alimentary morsels to the fauces' as Owen puts it (1832*b*, p. 23).

### 13.2. *Process by which Phoenicopterus antiquorum feeds upon mud*

Gallet (1949, p. 42) gives no size range for either the 'organic mud' eaten, or for the 'coarse sand' that is left behind (p. 451); but he says that the mud contains no recognizable plant or animal remains, and his photographs (Gallet 1949, pp. 39 and 40) look as if it is the coarser particles that are rejected. Yet he claims (translated literally, with my italics, P. M. J.) that 'the mud stirred up by . . . the feet is *searched* and *filtered by the beak* and yields up to the bird all that is organic'. 'Searching' seems improbable when no animals are present, and if my interpretation of the relative sizes of the particles is correct, it is clear that their separation can only be achieved if the normal direction of filtration is *reversed*; the mud must presumably be sucked in while the gape is practically *closed*, and the marginal platelets (the normal filter) be used to *exclude* the sand grains. The mud must then be quickly swallowed, before the tongue moves forward and pushes it out of the bill again, as could happen on these assumptions, since even the inner lamellae could do little, or nothing, to prevent its escape. Differential sedimentation may, however, play some part in the process. The bill is clearly used to scrape material out of the circular moat towards the

central mound (p. 456), much as in nest building. This would heap up the supply to some extent, while the jig movement would stir up both sand and mud; then, as the sand naturally settles by gravity more rapidly than the mud, it would leave an accumulation of the latter to be sucked into the bill. Neither of these processes, however, affords a true case of filtration.

The problem of the quantity of water and salts which must be imbibed at the same time will be discussed later (§ 14·3), but it is difficult to imagine by what means, if any, the stomach contents could be kept so compact and nearly fluid-free in this type of feeding, as they are in the true filtration of larger objects.

### 13·3. *Processes of feeding in Phoenicopterus ruber and Ph. chilensis*

Evidence from the form of the bill and the sizes of the lamellae and food strongly suggests that there is no appreciable difference in these respects between the three species of *Phoenicopterus*, and that the process of filtration postulated for *Ph. antiquorum*, when collecting whole organisms as food (§ 13·1), should be equally applicable to both *Ph. ruber* and *Ph. chilensis*. There is one possible difference in *Ph. ruber*, where the inner lamellae may be better able to 'feel' and hold smaller objects, because they are brought closer together across the mouth cavity when the bill is closed, than they are in *Ph. antiquorum* (p. 431).

What happens when *Ph. ruber* feeds on mud seems to be somewhat different from that postulated for *Ph. antiquorum*. *Ph. ruber* is reported to feed on mud containing as much as 90 % organic matter (p. 457), and Zahl (1953, p. 183), who watched young birds of this species feeding in lagoons on Inagua, came to the conclusion that they just 'gulped' the mud down, apparently without doing any filtration at all. He later found low mounds showing above the falling water level and surrounded by circular depressions half a metre in diameter. These he thought had each been formed by one bird feeding; but he gives no conclusive evidence that his mounds were not, perhaps, the remains of old nests. Even if they did result from feeding, they seem hardly to be the same as the 'feeding scars' figured by Gallet (1949, plate facing p. 41). The mud in the Inagua lagoon was so rich that only 10 % was indigestible, and even if this were all gravel, coarse enough to be excluded by the bill, it would provide comparatively little material of which the bird could make a central mound.

### 13·4. *Process of filtration when Phoeniconaias minor feeds upon diatoms or minute algae*

*Ph'naias minor* has not so far been kept alive in this country, and no close observation on its feeding has been possible; but the very small size of its natural food, and the compact, almost liquid-free mass of it which is found in the stomachs of freshly killed specimens, make it certain that the food is obtained by a true and efficient system of filtration. The field observations of Ridley *et al.* (1955, p. 148) did not reveal any important difference in the feeding movements between this species and *Ph. antiquorum*, except that the bill of the former is always held near the surface of the water. It may be assumed that the bill and tongue are moved in a similar way, and at about the same speed, in both species; but there are various important structural differences which must affect the details of filtration in *Ph'naias minor*.

The marginal hooks and leaflets here form the excluder; but they allow the bill to close

so that the inner lamellae on the two jaws meet across the deep gape, where their fringes form the filter (§ 12·2). Moreover, the broad, flat lamellated areas carry a whole succession of filters, instead of only one, thereby presumably increasing the efficiency of the system for catching the food, but also increasing the difficulty of collecting the catch for swallowing (figure 12).

The tongue is small and fits snugly into the nearly tubular cavity of the lower jaw, so that together they can form a very efficient pump (figure 5). The recurved spines on the tongue end in fine bristles (§ 7·2, and figure 17 *b* and *c*) which must be able to brush the collected food particles towards the gullet, despite their small size and the fact that they are not entangled in mucus, as they are in many other microphagous feeders.

Although the process of filtration within the bill cannot be proved, a reconstruction in four stages can now be postulated.

(1) It seems clear (figures 26 and 27, plate 15) that, as the tongue is drawn back with the bill closed, water and suspended food are sucked in all along the gape (white arrows, figure 12) between the marginal hooks and leaflets. These act as excluders (figure 19 *b*), preventing large particles from entering the bill.

(2) The *inflowing food current* can then pass most easily along the relatively wide diagonal grooves between the aligned platelets. These are so orientated as to lead directly from the spaces between the marginal excluders, inwards and backwards towards the central space left by the tongue as it withdraws (figure 5 and arrows, figures 26 and 27, plate 15).

(3) As the tongue moves forward, the water is driven out of the bill again and must pass through the filters (figure 19 *a*); but the exact way in which this is achieved is not obvious. There seem to be two possibilities, which are not mutually exclusive.

(a) If only the *outflowing current*, instead of retracing the way of least resistance along the diagonal grooves, could be directed transversely to the bill into the fringes of the platelets, along the old lamellar lines (p. 435, and black arrows, figure 12), wonderful filtration would result; but, at present, no mechanism for achieving this suggests itself, except that in most positions it is the shortest, though not the least obstructed, route to the exterior. However, the feeding of *Ph. antiquorum* lends some support to this possibility, since it shows that water drawn in through the submerged distal part of the bill can be ejected from the proximal part of the gape, rather than returning whence it came (p. 453).

(b) The alternative possibility, although not wholly satisfactory, may be explained by turning to the photographs of the largest platelets on the lamellated area (figures 26, plate 15, and 28, plate 16), where two features, that have not so far been considered, become apparent. Not being rigid, the platelets tend to 'wind', or twist, so that their fringes become flexed until they overlap the next blade in the same diagonal row (figure 15). All the blades are also inclined inwards towards the tongue, and, like small valves, will offer less resistance to water or particles passing inwards along the diagonal rows, in the direction of the arrows on the photographs (plates 15 and 16), than they would to the reverse current. When the water is being forced out of the bill, the platelets will tend to resist it, and their fringes will flap out across the diagonal channels, as far as they can reach. But, although this may reduce, it cannot close the channels enough to form a complete filter across the outflowing current, if this returns along these channels. It seems possible, however, that if the bill is sufficiently tightly closed, the channels could be largely

blocked by the diagonal rows of platelets on the two jaws interdigitating with each other across the gape, as they do on the right-hand side of figure 25, plate 14. Apparently, the jaws cannot close tightly enough for the rows to interdigitate on both sides of the bill at once, because of the marginal hooks; but a very slight lateral movement would allow of their doing so on one side at a time. Raising the upper jaw less than 1 mm vertically would be enough to spoil the filter, by moving the platelets away from their interdigitating position and opening the diagonal channels (left-hand side of figure 25), whereas a small *oblique* movement would allow them to remain in contact, and would also provide the 'carding' action, described below (p. 477), as a means of cleaning the platelets of their catch. (A relative lateral displacement of 3 to 4 mm between the tips of the jaws occurs easily, in an otherwise stiff, fixed specimen.) Quickly repeated oblique movements might then allow of a continuous phase of filtration (and food collection) on one side of the bill, provided that the consequent opening of the gape on the other side did not too greatly impair the pumping efficiency of the whole system. A rough calculation shows the volume of water moved by each stroke of the tongue to be little more than 0.5 ml.; and this, allowing for the volume occupied by the platelets, will fill the whole depth of the gape when this is rather less than 1 mm wide. Since the tongue changes direction eight times a second, it will tend to oscillate this volume of water to and fro in the gape rather than to produce a steady flow through the filters. Under these circumstances, the multiplicity of the platelets may well set up small vortices, which will also help to entangle the algae or diatoms in the fringes.

(4) *Cleaning the platelets of their catch* presents another problem, since food can apparently be caught on any part of the lamellated areas, and most of it is then out of reach of the tongue, confined within the tongue groove in the lower jaw. The inflowing water may help to wash some of the catch inwards along the diagonal channels, but this hardly seems sufficient. The idea of the 'carding' action, referred to above as bringing the food within

#### DESCRIPTION OF PLATE 14

FIGURE 20. *Ph. antiquorum*. Profile of adult, J3, with bill not quite as fully closed as possible. The marginal hooks and leaflets are clearly visible on the upper jaw (a group have been removed just distal to the bend, B).

FIGURE 21. *Ph. antiquorum*. Transverse section at BN (figure 20). The tongue is large and carries large recurved spines; its hyoid skeleton is nearly central; marginal leaflets, Pls, cross the gape (cf. figures 2 and 8*b*).

FIGURE 22. *Ph. antiquorum*. Transverse section at D (figure 20). The inrolling of the marginal hooks, Pks, can be seen to prevent complete closing of the gape. The inner platelets are visible on the concave lamellated area of the upper jaw (cf. figure 8*a*).

FIGURE 23. *Ph'naias minor*. Profile of adult male, R 792. The bony stiffening of the 'throat', *th.*, in front of the feathers, shows well in contrast to the soft skin in *Ph. antiquorum*, figure 20 above.

FIGURE 24. *Ph'naias minor*. Transverse section at BN, showing relatively small tongue and deep, flattened lamellated areas (cf. figure 11).

FIGURE 25. *Ph'naias minor*. Transverse section at D, showing the upper jaw sunk between the expanded borders of the lower jaw (cf. figure 12).



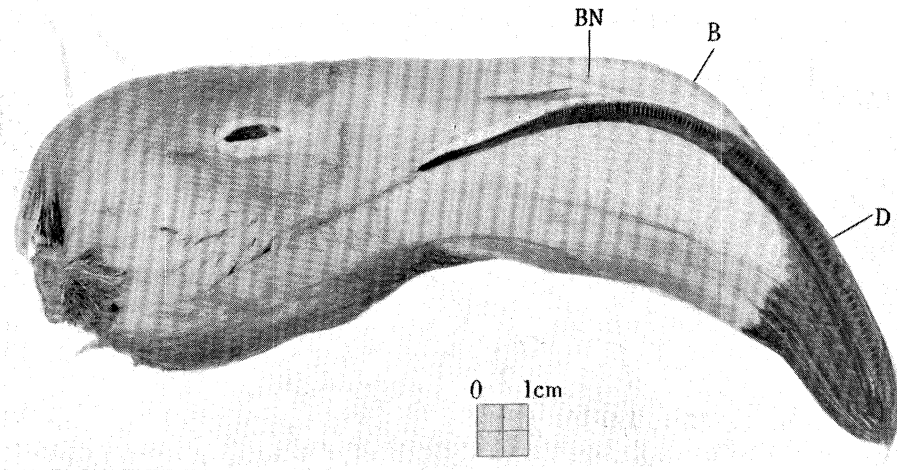

FIGURE 20

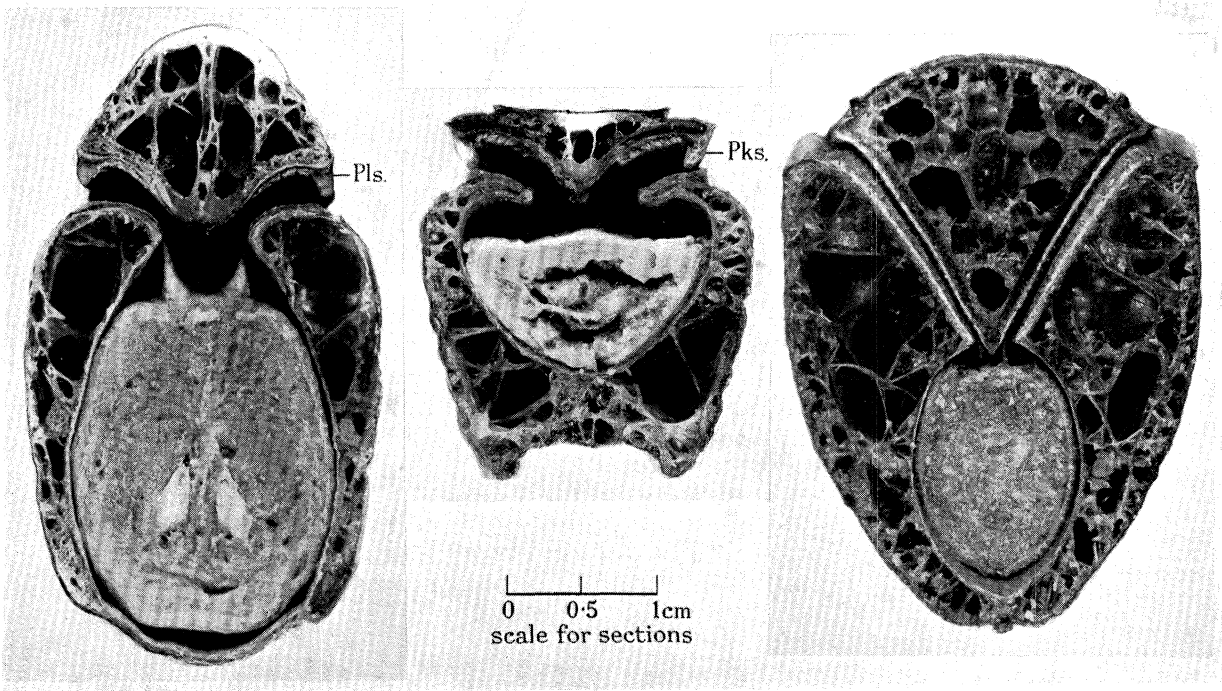

FIGURE 21

FIGURE 22

FIGURE 24

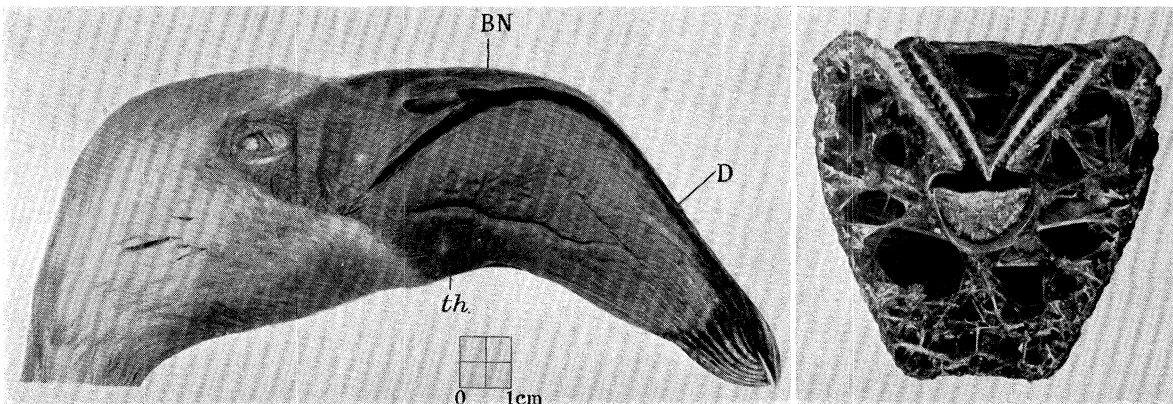

FIGURE 23

FIGURE 25

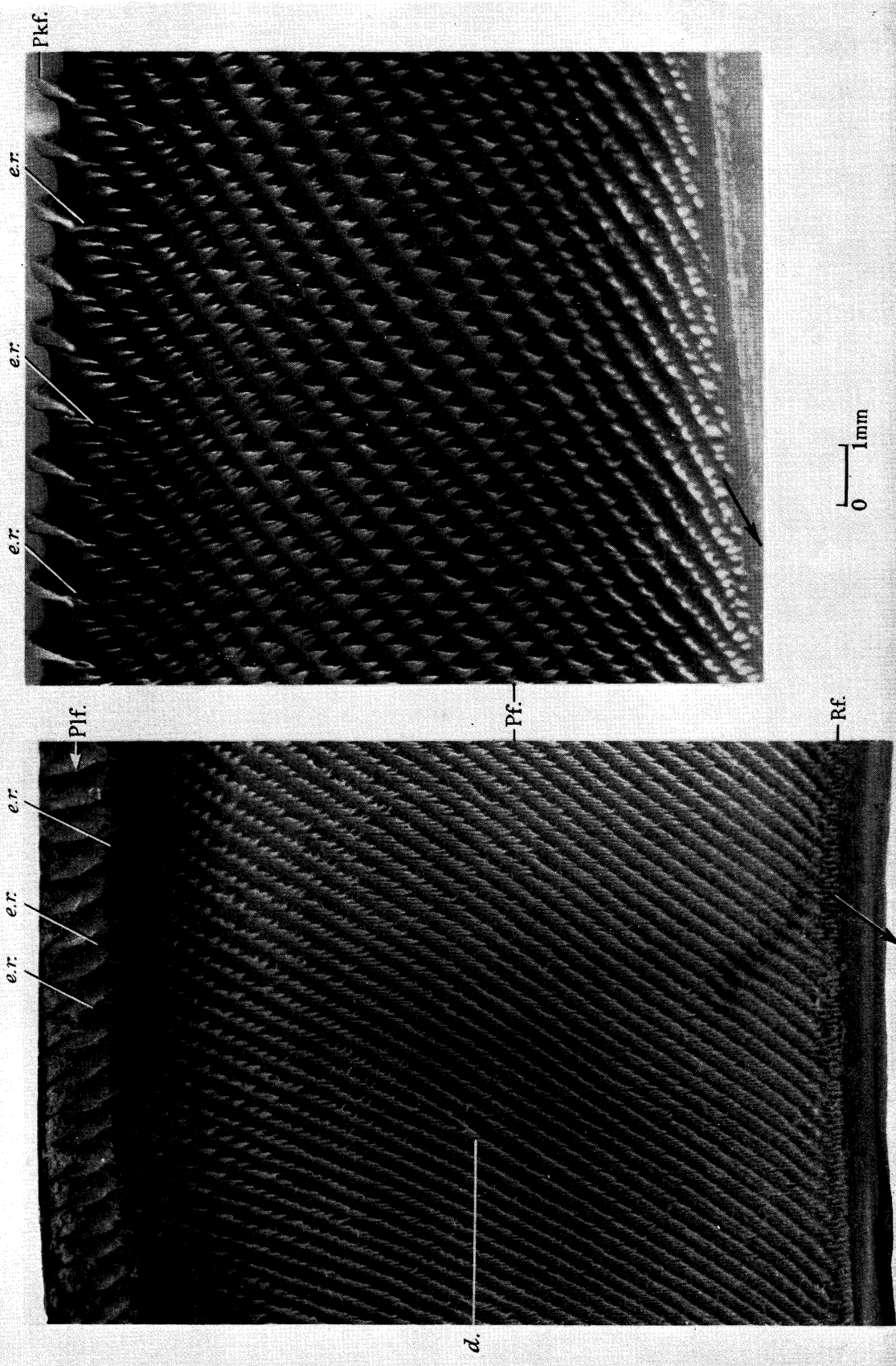

FIGURE 27. *Phinaias minor*. Surface view of maximum width of the lamellated area of upper jaw at BN, with fringed marginal leaflets and proximal inner platelets, very much smaller than those on the distal part of the bill in figure 26. The magnification is the same.

*d.* point where two diagonal rows converge; *e.r.* extra diagonal rows, not ending at a marginal platelet; *Pkf.* fringed marginal hook; *Pif.* fringed marginal leaflet; *Pf.* fringed platelet; *Rf.* fringed ridge.

FIGURE 26. *Phinaias minor*. Surface view of the whole width of the lamellated area of upper jaw at D, with marginal hooks at the ends of diagonal rows of fringed platelets (see below for orientation).

The photographs in plates 15, 16 and 17 are surface views of different parts of the lamellated areas lining the bills of flamingoes; all are from the right-hand side of the bill; all are equally magnified ( $\times 10$ ); and all are orientated so that the tip of the bill is towards the top of the page. Photographs taken nearest the tip are also at the top. The margin of the upper jaws is to the left, and of the lower to the right; so that if, for instance, plates 15 and 16 are brought together they will be orientated to one another as they would be across the gape in the bird's bill. Plate 17 would have to be folded down the middle to achieve this. For explanation of arrows pointing towards the tongue, see text (pp. 475 et seq.).

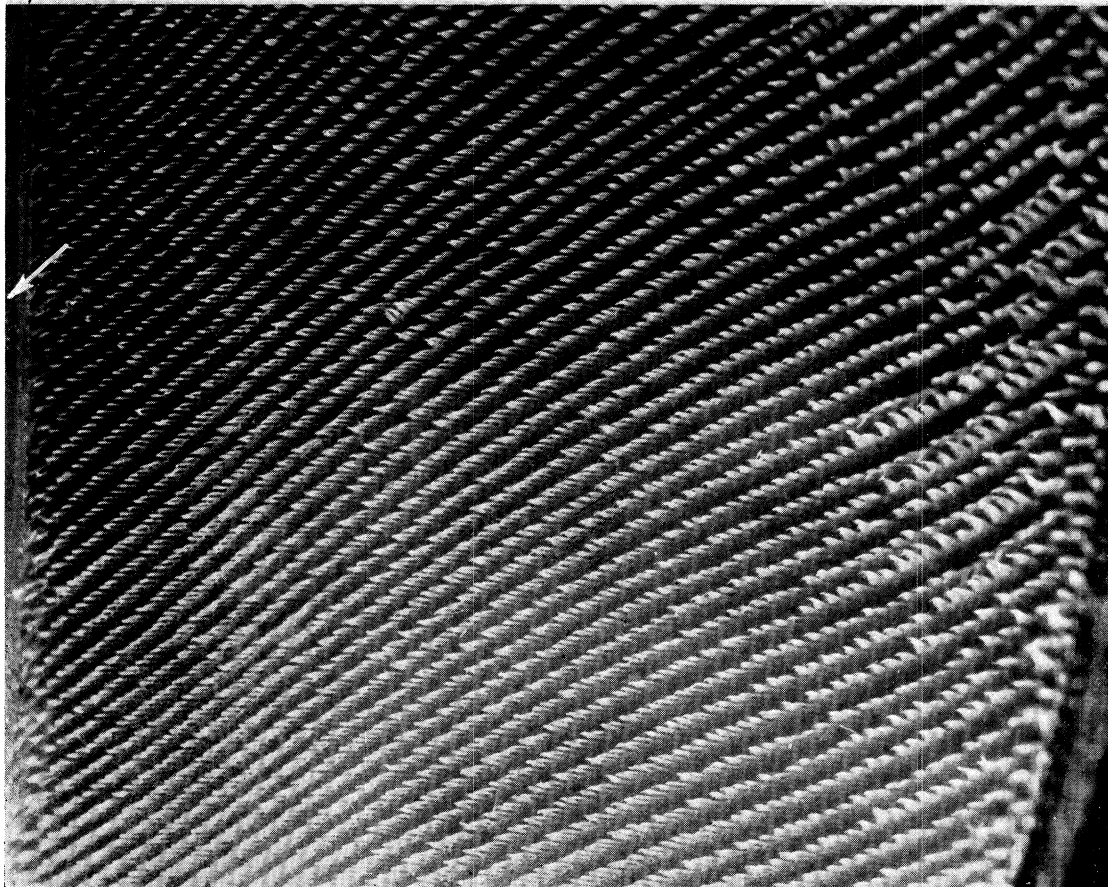

FIGURE 29. *Phinaias minor*. Surface view of the lower jaw at BN', with small proximal inner platelets (cf. figure 27, taken from the corresponding region of the upper jaw). Rf.g., the collecting trough on the median edge, formed by a longitudinal fringed ridge (cf. figure 11).

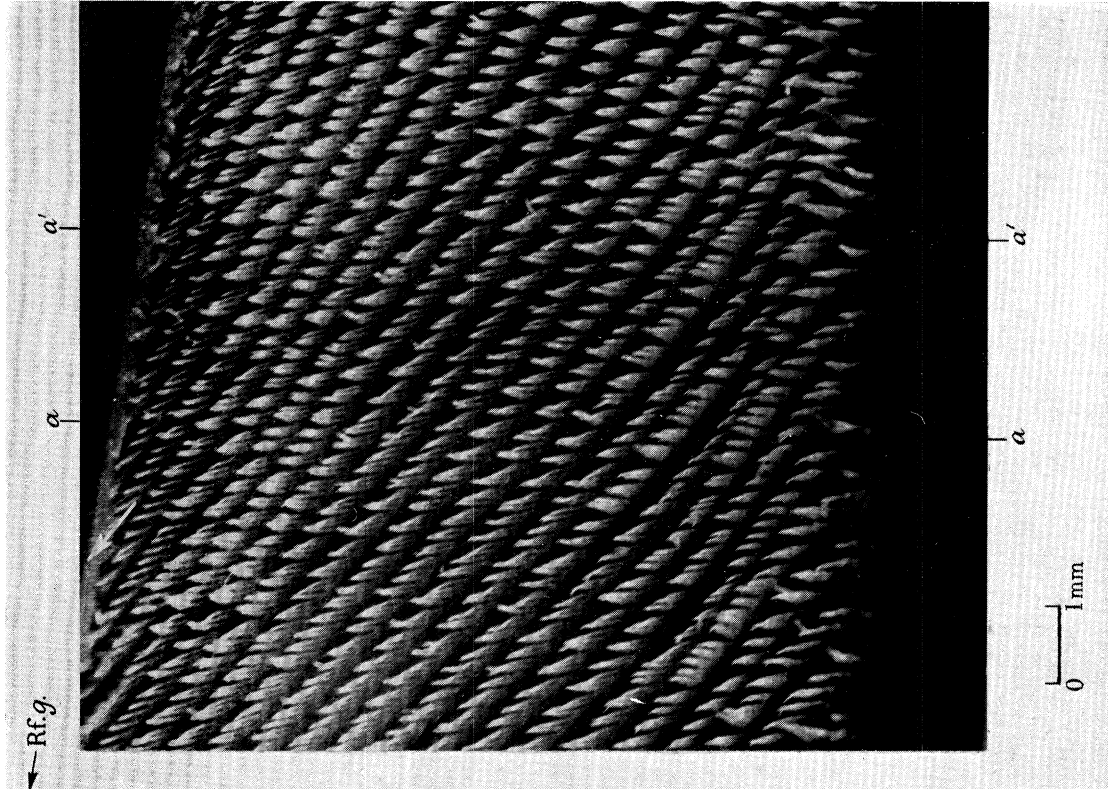
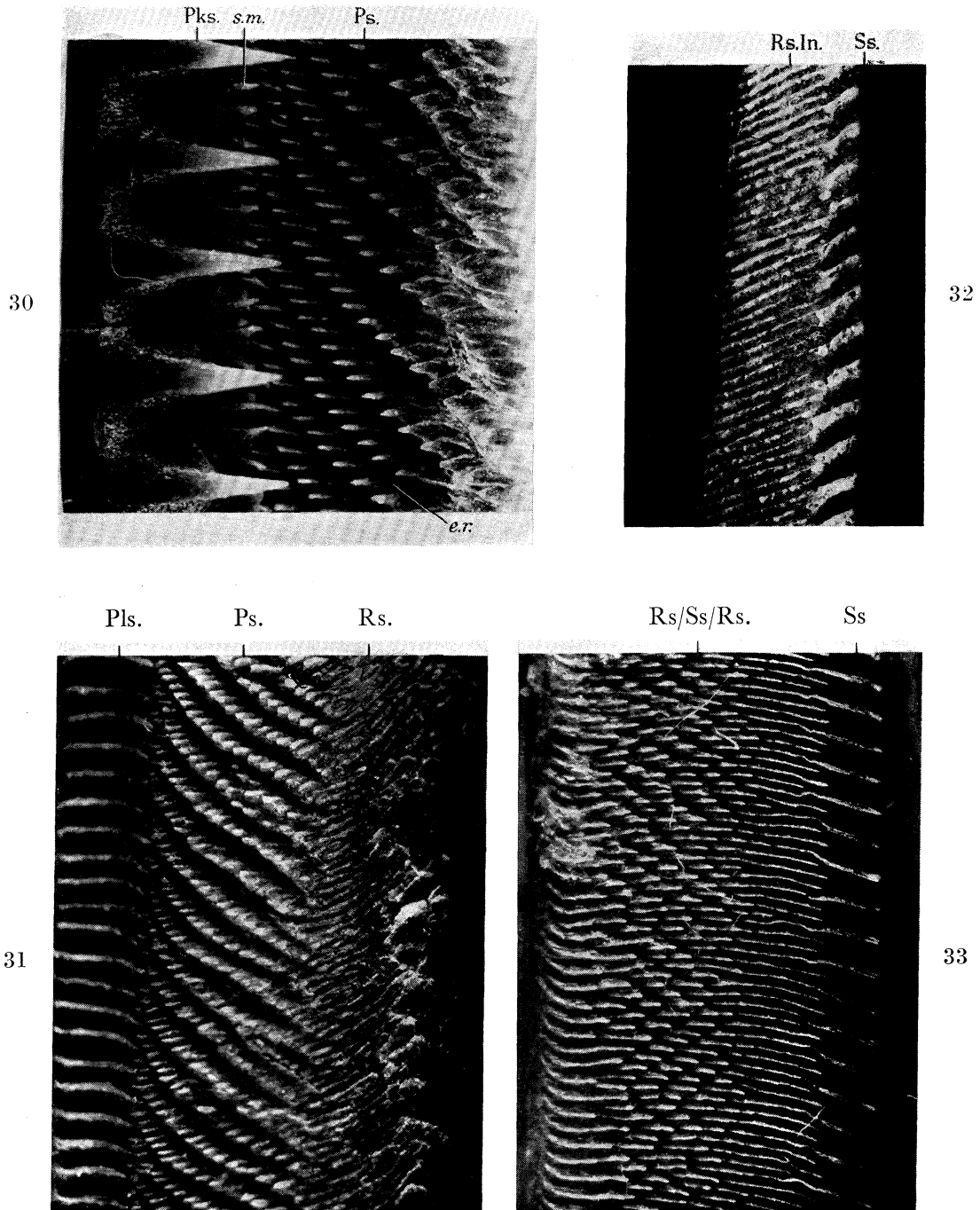

FIGURE 28. *Phinaias minor*. Surface view of the whole width of the lamellated area of the lower jaw at D' (orientation as in plate 15). A strip 2 mm wide, between aa and a'a' is analyzed in text figure 15.





Lamellae of *Ph. antiquorum*. The magnification ( $\times 10$ ) and orientation are the same as in plates 15 and 16. Lateral margins are to the sides, and median edges to the centre of the page.

FIGURE 30. Surface view of the whole width of the lamellated area of *upper jaw* at D. The smooth marginal hooks, Pks, tend to obscure the submarginals, *s.m.*, which are considerably farther from the camera. The inner platelets, Ps, are large here, as in figure 10*a*; they form diagonal rows and an extra row, *e.r.* A similar area is analyzed in figure 9.

FIGURE 31. *Upper jaw* at BN, with close-set marginal leaflets, Pls, and inner lamellae slanting across the area and forming some platelets, Ps, but persisting medially as smooth ridges, Rs.

FIGURE 32. *Lower jaw* at D', with smooth inner lamellae forming ridges, Rs.In. Outer lamellae here, and in figure 33, are serrated, Ss (cf. figure 10*b*), but the peaks do not show as they come towards the camera (cf. figures 8*a* and 22, plate 15).

FIGURE 33. *Lower jaw* at BN', showing partially serrated inner lamellae, Rs/Ss/Rs, with the peaks roughly aligned diagonally; there are two or three between adjacent outer lamellae, Ss.

reach of the tongue, is derived from a mechanical model supplied by the 'carders', or 'hands', used for carding wool for the spinning wheel. The carders are flat boards carrying rows of slightly flexible curved metal hooks, all facing one way, in an arrangement very like the platelets on the lamellated area of the bill. The pair of carders facing one another may then be taken as a model of one side of the bill of *Ph'naias minor*; one carder representing the lamellated area on the keel of the upper jaw, and the other the corresponding area on the inflexed border of the lower jaw. Wool, placed on the carders and combed until it is caught under the hooks, represents the algae, caught under the platelets on the bill. If the carders are now brought lightly into contact with one another, with the hooks on both hands facing downwards, a very few, short, up and down strokes suffice to produce all the wool, with dramatic and convincing effect, in a neat roll at the lower edge of the pair, where the tongue would be.

It follows that 'champing', or rubbing, the upper jaw up and down upon the lower should roll the collected food out of the filters. Although it is difficult to be certain, from fixed material, how big a movement would be necessary, any such movement should bring the food to the crest of the keel and the median edge of the inflexed borders, where the shallow gutter (Rf.g., figure 11) may help to prevent its slipping down the sides of the tongue, instead of being collected by the recurved spines that push it back to the gullet.

As with filtration, so also with cleaning, the triangular shape of the upper jaw makes it impossible for either process to take place by oblique movement on both sides of the keel at the same time. It may well be that the side of the bill that is used is that which leads, as the head is swung from one side to the other through the water.

#### 13.5. *Process of filtration in Phoenicoparrus*

In *Ph'parrus andinus* the form and size of the bill and the arrangement of the platelets on the lamellated areas are so closely similar to those of *Ph'naias minor* that there are no grounds for suggesting any major difference in the process of filtration in the two species. Unfortunately, data about the tongue are lacking. The main difference lies in the platelets forming the filter in *Ph'parrus andinus* (pp. 444 and 469), since the few that have been examined are more widely spaced than those of *Ph'naias minor*, and they lack the fringe which gives the filter of the latter species so fine a mesh. The filter formed in *Ph'parrus andinus* must, therefore, be of a relatively coarse mesh; but this need not affect its use in filtration, nor the mode of collecting the catch from the platelets by 'champing' the upper jaw on the lower, as in *Ph'naias minor*.

In *Ph'parrus jamesi*, some at least of the inner lamellae form fringed platelets within the same size range as those of *Ph'naias minor*; but the form of the bill introduces new problems. It is so short that the amount of food that can be taken in at each mouthful must be relatively small, and the upper jaw is so narrow that the lamellated areas are much shallower than in either of the other deep-keeled species. This must so reduce the filtering area on the bill as to suggest that either the birds must spend more of their time feeding, or that the type of food collected, or the process of filtration itself, must be distinctly different from that of *Ph'naias minor*. It is possible that a more coherent mass of algae, such as *Nostoc*, might require less prolonged filtration than diatoms, or that larger organisms (*ca.* 1 mm instead of 0.01 mm) might be retained by the marginal lamellae, after the manner of *Ph. antiquorum*.

But neither of these alternative suggestions provides a function for the fringes on the inner platelets. Are these a relict, or do the birds feed on some even more specialized diet than has yet been suggested? Only direct evidence could answer these questions; but *Ph'parrus jamesi* has not been seen since the beginning of the century, and it is possible that the food on which these highly specialized birds depended may have failed.

#### DISCUSSION

If, as now seems certain, all flamingoes normally feed by active filtration of water or watery mud, many aspects of their life must be affected. The primary effects will be upon the diet obtainable by each species; but this, in turn, will tend to restrict their distribution to localities where ecological conditions allow the development of an adequate food supply. Since this usually means brackish water conditions, physiological difficulties may arise, and be overcome, in part, by the very process of filtration.

The evolution of their highly specialized filtering structures will be briefly discussed in the final section.

#### 14. EFFECTS OF FILTER-FEEDING UPON THE ECOLOGY OF FLAMINGOES

##### 14.1. *Effects of filter-feeding on their diet*

###### *The diet of Phoenicopterus*

In considering the food records of this genus it became apparent that a great variety of both animal and plant material could be made use of by all three species, although an exception has long been claimed for *Ph. ruber* by many American writers (e.g. Chapman 1908, p. 153; Klingel 1942, p. 162), who believed that the diet of this species was strictly limited to *Cerithium*. This was particularly interesting, since it appeared to be almost the only case among birds where the diet of any species was limited to one food organism, i.e. that the species was 'monophagous'. The fact is, however, that when *Cerithium* fails, even *Ph. ruber*, like *Ph. antiquorum*, can also subsist on 'mud', which includes a variety of microscopic plants and animals (§ 10.1). Moreover, other molluscs are also eaten, though it remains true that *Cerithium* forms the staple food.

If *Ph. antiquorum* feeds by filtration in the first way postulated above (§ 13.1), the collection of food organisms of the size of *Cerithium* is almost mechanical. For the width of the gape imposes an upper size limit on the particles that can enter the filter in the bill, and the spaces between the outer lamellae determine the lower size limit of the particles that can be retained and eaten. If, in a given locality where the birds are feeding, one particular kind of animal is not only very abundant, but falls within this size range, it will automatically be collected and eaten in great quantities. If, in fact, it is the only species within the size range of the filters, it will be collected exclusively, as is *Cerithium* where *Ph. ruber* usually feeds. Where *Ph. antiquorum* feeds in the Camargue, there are three species of *Paludestrina* which all fall within the size limits imposed by the filter and excluder, and all are collected; but so, also, are varying numbers of other organisms, such as *Sphaeroma*, *Artemia* and plant seeds of similar size. On the other hand, it seems that in Port Sudan and Somaliland, the mollusc *Tympanotomus fluviatilis* was the only species that 'filled the bill' for *Ph. antiquorum*, so, for the time being and in that locality, this flamingo became as 'mono-

phagous' as *Ph. ruber*. Since all three species of *Phoenicopterus* have also long been known to feed chiefly on bread or rice in captivity, it is surely time that the myth about monophagy was dropped. Flamingoes may choose a feeding ground where a preferred food organism predominates; but they have no more power than other microphagous feeders of selecting one organism for food and rejecting any others of the same size, coexisting in the same area. In other words, the birds can select the habitat in which they feed, but not the organisms on which they feed. When, in certain areas, the diet is limited to one species, like *Cerithium*, this must be regarded as an ecological accident, not as an example of a marked food preference.

When all food organisms that can be collected by filtration have disappeared, either as a result of 'over-fishing' or by reason of climatic factors, the flamingoes can either go elsewhere, or eat mud. The adults fly well, and though the flocks are large, they are few and can fairly easily find fresh feeding sites; they may not need to return to the same place for two or three years, until the food population is built up again. It is, perhaps, only in the nesting season, when moving on is unlikely even for the adults and impossible for the unfledged young, that they must resort to eating mud, or starve. It is particularly the young birds of *Ph. antiquorum* and *Ph. ruber* that are known to eat mud (pp. 456 and 457). On Inagua, the adults that could fly soon moved on elsewhere.

#### *The diet of Phoeniconaias*

*Ph'naias minor* was thought to be like *Ph. ruber* in having a restricted diet, since the first stomach contents examined consisted wholly of *Spirulina*; but more recent evidence (§ 10·2) has shown that though it commonly forms a large part of the diet of this flamingo in East Africa, it may in quite normal circumstances be mixed with other algae or diatoms, or it may be replaced entirely by diatoms. Only a few very alkaline lakes where *Ph'naias minor* feeds are recorded by Beadle (1932, p. 205) as having no trace of animal plankton; all the rest have at least rotifers and protozoa as well as the algae, if not some Crustacea, the smaller of which will presumably be collected by the flamingoes, but are too rare or fragile to be recognized in the stomach contents, or to form an important part of the diet. The exact mixture eaten seems primarily to be determined by the environment, limited only by the size of the filters.

The use of *Spirulina* as a main source of food is particularly interesting, not only because of its small size, but also because it is so unusual for blue-green algae to enter into any food chain. Fish (1951, p. 900) found evidence that blue-green algae, even when collected in the stomach in large quantities by *Tilapia esculenta*, are not digested; so that these fish virtually starve, while their stomachs are full, unless diatoms are also present. Percy has recently made a careful examination of the whole alimentary tract of several specimens of *Ph'naias minor* that had been feeding on either blue-green algae or diatoms or both, and has found good evidence that both are equally digested by the flamingo, as might have been expected, but was previously unproven (Ridley *et al.* 1955, p. 151).

There is no direct evidence, as yet, of *Ph'naias minor* eating mud when other food fails, as *Phoenicopterus* can do; but, from the form of the bill and its filter considered mechanically, it should be equally easy for it to do so. In normal filter-feeding, stones and gravel are excluded by the marginal platelets, and the algae which are retained by the inner platelets

are probably as fine as fine mud; there should, therefore, be no need for this species to change its normal method of feeding, except to push its head down until the bill reaches the mud, instead of keeping it close to the water surface. This change in behaviour must have been achieved by the few damaged birds which managed to collect chironomids and seeds from the mud of Elmenteita (p. 460). It is the more surprising that they did not appear to ingest much mud in the process, but there may have been good physiological reasons for this (§ 14.3).

It would be interesting to have details of what *Ph'naias minor* finds to eat in other, widely scattered localities in which they occur, such as Madagascar, South Africa and north-west India; and to know whether they always seek out a water-bloom of plant material similar to those that they find in Kenya, or whether whole flocks, as distinct from rare individuals, ever find any source of animal food sufficiently small in size and abundant in quantity to meet their needs. It is tempting to suggest, on theoretical grounds, that such large birds could only maintain themselves by being in the main herbivorous and feeding directly upon the 'primary producers' in the ecosystem, rather than trusting to the inevitably smaller quantity of nourishment to be obtained from an intermediate 'consumer', especially when they cannot thereby take advantage of feeding upon a larger prey, because of the scale of their filtering system.

#### *The diet of Phoenicoparrus*

Reports here, as we have seen, are little better than rumours (p. 460); but the filters are so similar in general form to those of *Ph'naias minor* that it seems in the highest degree improbable that they should not be used in the same way for filter-feeding and for exercising a similar control over the food collected. The filters of intermediate-sized mesh described for *Ph'parrus andinus* have interlamellar spaces measuring between 0.06 and 0.14 mm across (p. 469), and are suitable for collecting small Entomostraca or water mites, of about  $0.1 \times 0.5$  mm or more, such as Walcott's (1925, p. 357) account suggests, and such as abound in certain types of saline pan (Hutchinson 1937, p. 111). The filters of *Ph'parrus jamesi*, which have smaller spaces, determined by the fringes on the platelets and measuring about 0.005 by 0.05 mm, would suit algae or diatoms of some sort, in accordance with Rahmer's (1886, p. 754) rather non-committal statement, even though we do not necessarily accept Phillipi's (1888, p. 160) implied identification of these as *Nostoc* and *Ulva* (p.461). More exact information of the food actually consumed by these Andean flamingoes is much needed.

#### 14.2. *The distribution of flamingoes in relation to habitats that meet their ecological needs*

Flamingoes are restricted by their filter-feeding to relatively minute forms of food (§14.1), and since the birds congregate in enormous flocks their need for vast numbers of food organisms may well be an overriding factor in their distribution. Ecologically speaking, only highly specialized or abnormal environments may be expected to produce large quantities each, of very few species; for only there will the number of species, and therefore of competition, be sufficiently reduced.

In aquatic environments such specialized conditions are chiefly caused by abnormal salt concentrations, always greater than in fresh water, and either greater or less than in normal sea water. These brackish conditions may occur in tidal estuaries, but as a rule the rapid



variations in salt content there do not favour the production of very large numbers of organisms. Evaporation is the chief means by which enclosed waters acquire a slowly increasing salt content, and this favours certain brackish-water species, like *Artemia* and *Cerithium*, on which flamingoes can feed. Climatic conditions causing such evaporation are largely confined to regions north and south of all the main deserts (see Hutchinson 1937, p. 98).

In these regions lagoons result on the sea coast, and are alternately filled with sea water or rain, and then evaporated more or less completely during the dry season. Salt lakes are formed inland and are what Hutchinson (1937) calls 'euendorheic', because water flows in from the surroundings, but rainfall is never sufficient to cause an outflow that reaches the sea, and salts therefore accumulate in varying proportions according to the soil. The euendorheic lakes in the East African Rift Valley are exceptional, since they lie close to the equator; but their altitude of nearly 2000 m is sufficient to take them out of the usual equatorial rain-forest climate into arid or semi-arid conditions. Similarly, the salt lakes at high altitudes in the Andes run continuously through latitudes where the Atacama Desert occurs at lower levels (table 17). East of the Andes, the salt lakes of Argentina belong to the same belt as the vleis and pans to the south and east of the Kalahari Desert in South Africa; but in South America they have a wider latitudinal distribution, perhaps from being on the dry side of the Andes.

The distribution of flamingoes is clearly related to that of lagoons and salt lakes. It will therefore be interesting to see how far the various species occupy, or have occupied, all those areas in the proximity of the great deserts of the world, where arid conditions occur.

One major exception is at once apparent, and that is the absence of flamingoes from such areas in Australia.

#### *The distribution of Phoenicopterus*

The distribution of *Ph. antiquorum* is shown in table 14. The localities are those from which the birds have been commonly recorded (e.g. Salvadori 1895); but the records have not been sifted to make sure that none refer to isolated specimens rather than large flocks, nor have the environmental conditions been ascertained for all the localities in aberrant latitudes.

In general, the localities show a close proximity to one or other of the deserts. Lake Baikal, which should be arid, since it is only 7° from the Gobi Desert, is so deep that its waters are not only fresh but extremely low in salt content (Halbfass 1923, p. 294), and it does not therefore seem a likely habitat to draw flamingoes so far to the north-east; but possibly, if they still visit this region, they find shallow saline lakes in the neighbourhood. I have seen no reference to their being there more recently than 1870; Issakov & Formozov (1946, p. 480), in their English summary, refer to flamingoes, presumably of this species, occurring periodically in the U.S.S.R. in years of drought, but they do not say what part of that vast area they are writing about. Dementiev & Gladkov (1951, p. 343) definitely omit Baikal from their map showing the distribution of this species.

The locality for *Ph. antiquorum* which seems the most aberrant, being right on the equator yet at sea level, is that given as the Gaboon coast (Salvadori 1895, p. 12). There is no obvious explanation for this.

Table 15 shows the localities from which *Phoenicopterus* has been recorded in the New World, again related to the deserts. The distribution of *Ph. ruber* is clearly much more restricted from east to west than that of *Ph. antiquorum*, because of the shape of the con-

TABLE 14. DISTRIBUTION OF *PHOENICOPTERUS ANTIQUORUM* IN RELATION TO DESERTS IN THE OLD WORLD

northern hemisphere					equator	southern hemisphere
distribution extending from 10° W to 110° E					...	12° to 40° E
Sahara, 10° to 30° N	Arabian, 14° to 34° N	Iran salt, 33° to 36° N	Indian, 25° to 30° N	Kara Kum & Gobi, 42° to 47° N	...	Kalahari, 22° to 27° S
localities to the north or west of each desert area					...	localities to north
Camargue*, 43° N	Smyrna, 38° N	<i>Caspian</i> † 37° to 47° N	<i>Punjab</i> , 30° N†	<i>L. Baikal</i> , 54° N	Gaboon coast, 0°	Angola, 7° to 17° S
W. Mediter- ranean islands, 39°	Palestine, 35° L. Menzala, 31°			<i>Mongolia</i> , 48°	<i>Kenya lakes</i> (2000 m), 0°	Walvis Bay, 24°
Cyprus, 35°	Suez, 30°				<i>Tanganyika</i> , 3° S	
N. African coast, 30°	Port Sudan, 20°					
Canary Is., 29°						localities to south
localities to the south of each desert area						
C. Verde, 16° N	Aden, 12° N	Euphrates, 30° N	<i>Sambhar L.</i> , 27° N	<i>Kirghiz</i> , 42° N		Mozambique, 24° S
Senegambia, 15°	<i>Shoa</i> , 10°†	Persian Gulf, 25°	Rann of Cutch, 23°			Cape Pro- vince, 34°
Guinea coast, 11°	Somaliland, 10°	Gulf of Oman, 23°	<i>Secunderabad</i> , 17°			
			Madras, 13° Ceylon, 6° to 10°			

\* *Ph. croizeti* found in Oligocene in Bavaria, 48° N.

† Places in italics are inland.

TABLE 15. DISTRIBUTION OF *PHOENICOPTERUS* AND *MEGAPALAELODUS* IN RELATION TO DESERTS IN THE NEW WORLD

northern hemisphere	equator	southern hemisphere
Arizona, 36° to 37° N	...	Atacama, 22° to 26° S
distribution from 115° W to 70° W	...	west of Andes, from 82° W east of Andes to 50° S
localities to the north or west of the desert	...	localities to the north or west of the desert
<i>Megapalaelodus</i> sp. (Miocene)	...	<i>Ph. chilensis</i>
California, 40° to 35° N	...	Tumbez, N. Peru, 4° S
S. Dakota, 46° to 43° N	...	<i>Junin</i> , C. Peru, 10° S*
<i>Phoenicopterus</i>	...	Antofagasta, Chile, 23°†
localities to the south or east of the desert	...	localities to the south or east of the desert
Central America, 18° to 8° N	<i>Ph. ruber</i> Galapagos Is. 1° S, 90° W	<i>Ph. chilensis</i> <i>Chilean lakes</i> , 20° to 30° S* <i>Salar del Huasco</i> , 28°
	Bahamas, ca. 27° Florida Keys, 25° Inagua 21°	<i>Cordoba</i> , 32° S* Uruguay, ca. 35° Buenos Aires, 35° S. Pampas, 35° Patagonia, 40° to 46°.
Mexico, 30° to 15°	<i>Ph. stocki</i> (Pliocene)	

\* Places in italics certainly inland

† Sea coast?

continent; latitudinally, it is restricted between the equator and the northern desert. All the localities for this species fall within the one arid zone, except the two equatorial coastal records, including the Galapagos Islands to which *Ph. ruber* resorted fairly regularly at one time (Salvadori 1895, p. 9), though now they seem to be almost entirely confined to the West Indies. South of the equator *Ph. ruber* is replaced by *Ph. chilensis*, which is widespread both north and south of the southern desert area, and much more often found on inland waters than either of the other species.

There are no records of living species of *Phoenicopterus* occurring to the north of the Arizona Desert, but the fossil genus, *Megapalaelodus*, has been found in California (L. Miller 1950, p. 69) and in South Dakota (A. H. Miller 1944, p. 85), which are both to the west or north of the present desert. It is also interesting that two, more recent, fossil species, *Ph. croizeti* in the Old World and *Ph. stocki* in the New, have both been found distinctly farther north than any living species around the same longitude. L. Miller (1944, p. 81) sees this southward withdrawal of the suborder as comparable with that of many mammal groups within the same period, but does not venture any opinion on the climatic changes which may have accompanied the movement. He points out, however, that some of the fossil flamingoes are associated with definitely lacustrine deposits, and these contain large quantities of molluscs, not unlike *Cerithium* in size and abundance.

TABLE 16. DISTRIBUTION OF *PHOENICONAIAS MINOR* IN RELATION TO DESERTS IN THE OLD WORLD

northern hemisphere			equator	southern hemisphere
distribution from 10° W to 70° E			30° E to 40° E	18° E to 50° E
Sahara, 10° to 30° N	Arabian, 14° to 34° N	Indian, 25° to 30° N	...	Kalahari, 22° to 27° S
localities to the north or west of each desert area			...	localities to north
<hr style="width: 100%; border: 0.5px solid black;"/>			<i>Rudolf Crater lakes</i> ,*† Kenya, 3° N <i>L. Baringo</i> , Kenya, 0-30° N <i>L. Kikorongo</i> , Uganda, 0° <i>L. Hannington</i> , Kenya, 0° <i>L. Nakuru</i> , Kenya, 0° <i>L. Elmenteita</i> , Kenya, 0° <i>L. Naivasha</i> , Kenya, 0° <i>L. Natron</i> , Tanganyika, 2° S Kenya coast, 2° S	Aldabra, 10° S Madagascar, 12° to 24° Zambesi, 19° <i>Makarikari</i> , 20°* <i>L. N'gami</i> , 20°
localities to the south of each desert area				localities to south
Senegambia, 15° N	Eritrea, 15° N	<i>Sambhar L.</i> , 27° N*		Natal, 30° S
Guinea, 11°	<i>Shoa</i> , 10°*	<i>Secunderabad</i> , 17°		<i>Cape Province</i> , 34°
Cameroon, 5°	Somaliland, 10°			

\* Places in italics are inland.

† All the equatorial lakes are at high altitudes, up to 2000 m.

*The distribution of Phoeniconaias minor*

Table 16 shows the distribution of this species to be much more limited than that of *Ph. antiquorum* (table 14), although there is a considerable overlap in their ranges. *Ph'naias minor* does not reach any of the regions north of the northern deserts, nor does it, in consequence, spread as far to the east; and it is absent from many of the coastal areas that lie within its northern limits, for instance in the Red Sea and the Persian Gulf. A few places are peculiar to this species, according to the lists, including Madagascar and the atoll island, Aldabra, which lies 9-40° south of the equator but belongs to the Seychelles. The occurrence of *Ph'naias minor* close to the equator, on the Kenya coast, suggests an aberrant habitat that occupies the same relative position for this species that the Galapagos Islands do for *Ph. ruber*. Details of all these places, if this flamingo still visits them, would be of particular interest. Apart from this, the relation of the distribution of *Ph'naias minor* to Hutchinson's (1937, p. 98) latitudinal belts of euendorheic lakes is rather closer than for any of the species of *Phoenicopterus*. All the localities in northern Africa fall within the limits of 9° to 15° N, or else in the exceptional high-altitude equatorial belt. In India they are more spread out. Nearly all the South African localities are clearly related to the position of the Kalahari Desert.

In East Africa *Ph'naias minor* occurs mostly on strongly alkaline, brackish lakes; this seems to be necessitated by their use of *Spirulina* as food. This alga is confined to alkaline waters (Beadle 1932; Jenkin 1936), where it occurs in quantities that are roughly proportional to the alkalinity. It frequently, if not constantly, forms a water-bloom in six out of the eight lakes where *Ph'naias minor* most commonly occurs, including Lake Natron in Tanganyika and Lake Kikorongo in Uganda (table 16). Of the two lakes without *Spirulina*, Naivasha has abundant diatoms but is not visited by large flocks of the flamingoes, and Baringo has masses of *Microcystis flos-aquae* (Jenkin 1936, p. 176) which may serve to feed the birds for a time. Van Someren (1922, p. 11) records flamingoes as being very common on Lake Baringo, but gives no indication of their food; I did not see any there in 1929.

This correlation between alkaline water, *Spirulina* and *Ph'naias minor* suggests that the well-known periodic movements of this flamingo from one lake to another may be explained as a constant search for abundant sources of the algae, with occasional recourse to diatoms (p. 459).

Elsewhere too, this species is found predominantly on inland waters; but there is as yet too little evidence about the conditions in other areas to show whether the distribution of *Ph'naias minor* can always be explained on the lines that seem to be valid in East Africa. The waters of some of the scattered localities in which the birds occur are certainly brackish, and probably also alkaline like the surrounding soil, as in Damaraland, Lake N'gami (Sharpe 1884, p. 745) and Makarikari Pan (Roberts 1935, p. 13) in South Africa, and in the Lake of Sambhar in India (Hume 1872, p. 32).

#### *The distribution of Phoenicoparrus*

The two species were first found at high altitudes in the Andes around the Atacama Desert of north Chile (table 17), in what appears to be another exceptional area for euendothermic inland waters (p. 481), and one that is in many ways comparable to that occupied by *Phoeniconaias* in East Africa.

On the western side of the Andes *Ph'parrus jamesi* occurs above 4000 m in southern Peru, and in northern Chile as far south as Pisagua (Rahmer 1887, p. 160), and then is said to be replaced by *Ph'parrus andinus*, which has been found in all suitable localities, above about 3000 m, from Canchosa in Central Tarapacá to Maricunga in the Cordillera of Copiapó (Hellmayr 1932, p. 312). Farther east the two species appear to overlap, both having been recorded at different times from Sajama in the Oruro district of Bolivia (Berlepsch & Stolzmann 1906, p. 131; Hellmayr 1932, p. 312), and possibly also from the Puna de Atacama. Dr Paul Holmes (*in lit.* 1955) tells me that he saw a number of *Ph'parrus andinus* as far north as Lake Poopo, and even Lake Titicaca, on several occasions between April and September 1936. He adds that occasionally on Titicaca a white species has also been seen and this he takes to be *Ph'parrus jamesi*. It is interesting that these two species so rarely occur together, because there is sufficient difference in their lamellae and in the resulting mesh of their filters to suggest that their food organisms should not overlap in size, and that there should, therefore, be no close competition between the two species (§ 12·2). At the same time, the bill of *Ph'parrus jamesi* is so short, and its filtering area so small, that its survival may be in question. It does not seem to have been seen since Ménégauz (1909,

p. 222) reported six specimens from Jujuy,\* although special searches have been made for it on more than one occasion, at least in Chile (Goodall *et al.* 1951, p. 115).

*Ph'parrus andinus*, on the other hand, has certainly been recorded at least once since then on Laguna Colorada, a large, shallow lake at an altitude of over 4000 m in the centre of the Andes, in Puna de Atacama; this lake lies in a belt of exceedingly cold and arid country on the south-west border of Bolivia (Walcott 1925, p. 352). Rudolph (1951, p. 88) visited the same lake recently, and saw 'flamingoes as plentiful as ever'; but, unfortunately, he did not identify them specifically, although Walcott had claimed that *Ph'parrus andinus* was the only species in that region. It seems too far from the known range of *Ph'parrus jamesi*, or

TABLE 17. DISTRIBUTION OF *PHOENICOPARRUS* IN RELATION TO DESERTS  
IN THE NEW WORLD

southern hemisphere

Atacama, 22° to 26° S

western side of Andes	central or eastern Andes
localities at altitudes above 3000 m to north of the desert	

*Ph'parrus jamesi*

S. Peru, 15° S	Titicaca ?, 16° S
Isluga, Chile, 19° 20'	Sajama, Oruro, 17° 30'
Pisagua, Chile, 19° 30'	Jujuy, 20° ?
	Puna de Atacama, 24°

localities at altitudes above 3000 m both north and south of the desert

*Ph'parrus andinus*

(Pisco Bay, Peru)*, 5° S	Titicaca, 16° S
Tarapacá, Chile, 20°	Sajama, Oruro, 17° 30'
and southwards to	Poopo, 19°
Maricunga, Chile, 27°	L. Colorada, 22°
Salar del Huasco, 28°	Tucumán, 26°

\* Sea coast.

even of *Ph. chilensis*, for either of these to be a probable alternative. Laguna Colorada is significantly described by Walcott (1925, p. 353) as 'strongly alkaline', with several large springs at the north end, and with salt deposits, including sodium and potassium carbonates, sodium chloride and borax on the shores. I can find no analyses of lakes where *Phoenicoparrus* lives, though all are referred to as 'salt lakes', and seem to be euendorheic.

As their bill structure is so similar to that of *Phoeniconaias*, these species might be expected to occur in similar habitats. It is, therefore, rather disconcerting that Murphy (1936, p. 275) saw forty 'Andean flamingoes' feeding in a coastal lagoon; but perhaps the small numbers in themselves indicate that the sea coast is as rare a habitat for *Ph'parrus andinus* as it is for *Ph'naias minor*.

A full investigation of both these most interesting species would be well worth while; particularly if it proved possible to locate the elusive *Ph'parrus jamesi* in sufficient numbers to be assured of its continued survival, and to justify the sacrifice of one or two specimens in the hope of solving some of the mystery that surrounds this species.

\* This Jujuy appears to be in Bolivia or S. Peru, not Argentina; but, like some other place-names in S. America, I have failed to locate it for certain.

14.3. *The place of filtration in overcoming physiological problems that arise from feeding in brackish and alkaline waters*

Filter-feeding is familiar as a means of concentrating food for ingestion into the alimentary canal without too much liquid. As long as the filtering organism is living in osmotic and ionic equilibrium with its environment, as do many of the marine filter-feeders, concentration of the food is all that matters; but when organisms are feeding in a medium that differs widely in its osmotic and chemical properties from those of the animal's own body fluids, a new factor is introduced. It may then be of great physiological importance for the animal to control its ingestion of the medium with its food; it might, for instance, be as important for *Artemia* not to acquire excess salts by drinking too much brine with its food, as for *Cheirocephalus* not to dilute its internal salts by drinking the rain water in which it habitually feeds.

The problem for a bird feeding in normal sea water (*ca.* 35 g NaCl/l.) is more like that for *Artemia*; for the salts in its body fluids are much less concentrated (isotonic with 10.25 g NaCl/l. in the chicken, according to Botazzi 1908, p. 285) than those in the medium. Any excess salts absorbed in the intestine must be got rid of, presumably by active excretion through the kidneys, and at the same time some water at least must be acquired to make good the losses from the lungs and kidneys, minimal though these losses are, because of the reabsorption of water in the kidney tubules and the excretion of solid uric acid.

For flamingoes the physiological strain of these processes must become increasingly great as the waters in which they feed become concentrated by evaporation (§ 14.2). In the lagoons, where sea water is the starting point, the problem will be mainly one of osmotic balance, which could be restored by the birds' drinking fresh water, with or without some salt excretion from the kidneys. But in places like Kenya and Uganda, where the alkaline lake waters are so unlike the normal body fluids of vertebrates, particularly in their ionic balance, serious problems would arise for the flamingoes that swallowed and absorbed them, and could presumably only be solved by active differential excretion of ions through the kidneys.

The water of Lake Nakuru, for instance, which may have an alkaline reserve of 0.29 N, is less alkaline than Lake Kikorongo (0.4 N) where flamingoes also feed; yet even in Nakuru the hydrogen-ion concentration is between pH 10 and 11, whereas that of sea water and normal vertebrate blood is maintained close to pH 8, and pH 9 is known to be harmful to some organisms (cf. Jenkin 1927, p. 373). The ionic balance is different in different alkaline lakes, but, again taking Nakuru as an example, the normality of the chloride and carbonate anions in 1929 was about 0.055 and 0.29 N respectively (Jenkin 1936, p. 147); whereas in sea water it is nearer 0.5 and 0.0024 N respectively. The proportion of the cations is also significant, since the ratio of calcium to sodium in sea water is 1:38, whereas in Nakuru and Hannington it is only 1:480, and sodium unbalanced by calcium can be toxic to many living tissues. Since the sodium in Nakuru is only a half, and in Hannington a quarter, of that in sea water, it may be calcium which is dangerously deficient here, although it is greater in absolute amount than in some soft fresh waters which support a healthy fauna (cf. Beadle 1932, p. 203) but have equally low concentrations of other ions. There may also be a total lack of magnesium in the Kenya waters, as it

is all precipitated at about pH 10.5. The physiological dangers of these alkaline waters for most animals is well illustrated by the facts that the general fauna is markedly restricted (Jenkin 1936, p. 166), and that the alkali damages the outer surface of the flamingo's skin. It would be interesting to know how far the gut and kidneys of the flamingo can deal with such an unbalanced mixture of sodium and calcium ions; and whether filtration has acquired, in addition to its use in feeding, an equally important function in preventing excess salts from passing beyond the bill into the alimentary canal.

*The problem for Phoenicopterus antiquorum*

As long as this species feeds on such organisms as chironomids, *Artemia* or *Paludestrina*, it should be able to filter these out of the medium and so keep the stomach relatively free from ingested salt water. But towards the end of the summer, just as the mud dries up and the salts are on the point of crystallizing out (Gallet 1949, p. 43), *Ph. antiquorum* presents one of the most mystifying features of its existence. It apparently gives up filtration and takes to eating mud, swallowing it, salt and all, because it has no filter fine enough to separate mud from fluid (§ 13.2). Perhaps the largest salt crystals might be excluded by the outer lamellae; but there seem to be no means of avoiding the concentrated brine. Yet there are no records of this species drinking fresh water. The question, which might repay investigation in the Camargue, is whether some physiological safeguard may not be brought into play at this season. In addition to any system of excreting salts through the kidneys, the birds may use their abundant store of fat to supply themselves, in the emergency, with water of metabolism, as is done by some desert birds and mammals.

In Kenya, *Ph. antiquorum* can avoid most of the difficulty of ingesting unsuitable alkaline water by feeding only on relatively large organisms or seeds, which can be collected by filtration. On theoretical grounds it seemed to me almost impossible for these birds to feed on the minute algae in these lakes, because their only method of doing so would be to drink the suspension of algae in the water, in the same way as they consume the Camargue mud; the cost of ingesting such large quantities of unbalanced ions might well be too high a physiological price to pay. It was, therefore, with relief that I learned from the investigations of Ridley & Percy (1953, p. 108) that, in these alkaline lakes, *Ph. antiquorum* adheres persistently to filter-feeding and so avoids this physiological predicament.

*The problem for Phoeniconaias minor*

For this species, feeding on the algae in the alkaline lakes is made possible by the fine filters, which are as effective as need be in separating the algae from the noxious medium in which they grow, and delivering them in a relatively dry state to the birds' stomachs. Yet, unlike *Ph. antiquorum* for which there is no evidence of drinking, records are gradually accumulating to show that this species does drink frequently, if not regularly. One record comes from Nakuru (Gromme 1930, p. 438), and another from Hannington (Ridley *et al.* 1955, p. 148), where *Ph'naias minor* was seen to fly regularly for a considerable distance to reach fresh water. It is the more surprising that these last authors did not see any birds drinking during their sojourn on Lake Elmenteita; but, as they record the birds' flying away for a time daily, this may have been a flight to some more distant water supply, though the supposition is made less probable by the fact that the birds seem to have ignored

a freshwater stream which flows into this lake. Brown (1955, p. 164) has claimed that although *Ph'naias minor* can only live on the produce of alkaline lakes, 'they must have fresh water (though. . . they do not mind it boiling hot) and all the biggest concentrations' of these flamingoes 'are round the freshwater springs'.

A similar argument to that showing that *Ph. antiquorum* could not eat algae in alkaline lakes shows the improbability of *Ph'naias minor* eating the mud there. They apparently could collect mud by using their normal filtration process (§ 14.1); but if, as seems certain, the mud is impregnated with soda, the birds would be unable to separate the two, and so be unable to feed on the mud because of the physiological consequences.

Since the filtering system of the two species of *Phoenicoparrus* seems to be so similar to that of *Phoeniconaias*, it may be assumed that they are in the same position, in relation to feeding in physiologically unsuitable media.

It seems clear from these considerations that filtration may play an important part in reducing the physiological difficulties which flamingoes must find in feeding in brackish, and, even more, in alkaline waters. But the process is different for *Ph. antiquorum* and *Ph'naias minor*, even when they feed together in the same lake, and this should be taken into account in any further attempt to solve the problems raised here.

#### 15. AFFINITIES AND EVOLUTION OF FLAMINGOES

The subject of flamingoes and their exceedingly specialized bills cannot be left without speculating, however briefly, upon the effects which the adoption of this filter-feeding habit may have had upon their evolution and upon the evidence of their affinities.

The classification put forward from time to time for these birds reflects three possible views on their evolution from one avian stock or another. One view follows that of Linnaeus, who put them with the storks, and a strange assemblage of other forms, in the order 'Grallae'; Peters (1931, p. 140) subdivides the Grallae but keeps the flamingoes as a sub-order of the Ciconiiformes, an order which includes the storks, cranes, open-bills, ibises and screamers. A second view emphasizes the affinities between the flamingoes and the ducks, geese and mergansers by including them in the Anseres (e.g. Koenig 1888, p. 293; Plate 1922, p. 263). The third view stresses the independence of flamingoes from the adjacent forms: Huxley (1867, p. 460) put them in a separate order, 'Amphimorphae'; Salvadori (1895, p. 8) included them, between the Palamedea from one side and the Anseres from the other, in the order 'Chenomorphae'; while Tenison (1954, p. 76) accepts for them a separate order, the Phoenicopteriformes.

Whatever their exact relation with these other groups, it is clear that present-day flamingoes combine many characters of the Ciconiiformes such as long legs and bills, with the webbed feet, aquatic feeding and ground nesting of the Anseres. The skull and bill give support to the view that the flamingoes are rightly to be seen as intermediate between these two groups. Palaeontology seems to support a belief in their very early separation from other birds, for fossils from deposits as early as the Eocene, if not the Upper Cretaceous, have been allocated to the Phoenicopteriformes (Romer 1945, p. 604). In subsequent periods the length of leg of fossil forms has increased progressively, which supports the view that flamingoes have diverged from some duck-like precursor by acquiring long legs, rather than from stork-like forms by becoming web-footed. By the late Oligocene, fossil flamingoes



can clearly be attributed to the living genus *Phoenicopterus*, having acquired all the specialized bill characters associated with filter-feeding. Given a long neck, the inverted feeding position of the bill is only natural (p. 451), while the ball and socket jaw-joint (p. 412), the enlarged lower jaw, and the cylindrical space for the tongue, are all related to using the tongue as a pump for filtration (p. 472). Only the bend in the bill seems to be a relatively late acquisition, although it is of importance in filter-feeding, because it helps to keep the gape of more or less equal width along its length. Very few fossil bills have been found, but there is some evidence that *Palaelodus* (Milne Edwards 1869–1871, plate 82) of the Miocene, or early Oligocene, had a straight bill. It has also been claimed, on rather scanty evidence, that the bill of *Ph. croizeti* was less bent than those of living species (Lambrecht 1923, p. 346). The bend still appears late in individual development, the chicks having straight bills and picking up food with the tips for three or four weeks (McCann 1940, p. 24).

The inflexed borders of the lower jaw (pp. 414 and 416) not only help to complete the cylinder for the tongue as, perhaps, their primary function, but also provide a means of increasing the lamellated areas, in a way that has been fully exploited in the deep-keeled species by expanding them to carry a whole series of filters instead of only one (p. 469 and figure 12). But the evolution of these deep-keeled species seems to remain a closed book. The remarkable degree of similarity in form between the bills of *Ph'naias minor* and *Ph'parrus andinus* (p. 418 and figure 6a and b) seems to make nonsense of any attempt to postulate parallel evolution, despite their separation by the Atlantic, for a period long enough, presumably, to have allowed for the specific differentiation of *Ph'parrus andinus* and *Ph'parrus jamesi* in South America. There appears so far to be no trace whatever of any fossils which might show earlier links between the deep-keeled bills of these species and the shallow-keeled bills of the Phoenicopterid stock, from which their other characteristics are undoubtedly derived.

Of all the structures with which the present account has been concerned, the horny lamellae lining the bill show the highest degree of specialization in relation to filter-feeding, and yet offer the least hope of having any fossil history. They are structures which the flamingoes have in common with some of the Ciconiiformes as well as with the Anseres. Among the former, the Open-bill, *Anastomus*, has lamellae so long as to have a superficial resemblance to whalebone; but the bird is said to eat large molluscs and Crustacea (Loveridge 1923, p. 919), for which the lamellae can hardly be used as filters. In most of the Anseres, the lamellae are usually simpler than those of flamingoes; but both inner and outer series are present, in the form of smooth ridges, similar in general form to those on parts of the lower jaw of *Phoenicopterus* (Rs, figure 7a), though their use varies considerably in different genera. In the domestic goose, *Anser anser*, they are used solely as strong teeth, converting the jaws into saw-edged scissors, with which the bird can cut grass or slice up such solid objects as chunks of apple or cabbage stalk\*; but again there seems to be no trace of filtering in these birds. On the other hand, the ducks, such as *Anas platyrhyncha* and, to a more marked extent, the Shoveller, *Spatula clypeata*, do use the lamellae as filters in the same way as the flamingoes to retain food such as small insects, while the surrounding mud and water are washed out of the bill by rapid movements of the jaws, and probably also of

\* I am indebted to a tame specimen belonging to Dr S. M. Manton for a clear demonstration of these facts.

the tongue (Hesse & Doflein 1914, p. 241 and Abb. 192). The tips of the inner lamellae on the lower jaws of the Shoveller are slightly fringed (Zander 1908, p. 60), which seems to show that this is an inherent capacity of the lamellar structure.

From the detailed similarity between these ducks and flamingoes it can be conceded that both are making use of a common inheritance in having lamellae at all; but since ducks use their bills the right way up and flamingoes use theirs upside down, it seems more probable that specialization for filter-feeding has occurred independently in the two groups (Niethammer 1938, p. 351), rather than that both have retained a primitive habit indicating close relationship.

This is borne out by the evolution undergone by the lamellae within the Phoenicopteriformes. In *Phoenicopus* the outer lamellae are relatively simple and form a filter with a mesh of about 0.5 by 1 mm, which is comparable with that in ducks. But the inner lamellae already show the beginnings of that complex series of variations (§ 6), and in particular the breaking up into separate platelets (Ps, figure 7c), which has been crucial to their exploitation in the formation of fine filters in the other genera. The evolution of these inner platelets reaches its highest level in the deep-keeled species of *Phoeniconaias* and *Phoenicoparrus*, in which they are tall and closely set, and meet across the gape to form the filter. The mesh of filter thus formed in *Ph'parrus andinus* is of the order of 0.1 mm across. The final stage in the specialization of the platelets, in *Ph'naias minor* and *Ph'parrus jamesi*, has been the breaking up of the free edge of each platelet into a fringe (Pf, figure 7d), so fine as to form a filter with a mesh only 0.01 mm across, commensurate with microscopic algae and diatoms.

Further light might be thrown on what seem to be these successive stages in lamellar evolution by the study of their development; but this has not so far been attempted, though there are a few observations which may prove to be relevant. The lamellae are obviously subjected to much wear and tear during life, especially when used in alkaline water; but they are not materially altered in form in old birds, although they get darker with age, as if by progressive tanning. This, and their appearance of being continuously produced from below (figure 13), make it seem unlikely that they are shed at intervals and completely replaced like the horny feathers, even if such a process were compatible with continued feeding. Nevertheless growth is not entirely straightforward, since there can be fewer outer lamellae in an adult than in a young bird, even though the bill of the former is the longer (p. 431). The spacing of the lamellae is, therefore, not always proportional to the length of the bill. It would take much more material than has so far been available to determine exactly the effects which sex and age may have had in such a case; even more would be needed to elucidate the early development of the lamellae, of which the adult forms and functions have been shown to be so varied in the six species considered here.

#### REFERENCES

- Allen, R. P. 1956 The flamingoes: their life history and survival. With special reference to the American or West Indian flamingo (*Phoenicopus ruber*). *Res. Rep. Nat. Audubon Soc.* 5, 1-285.\*  
 Audubon, J. J. 1827-1838 *The birds of America, from original drawings*, 4. London: published by the author.  
 Audubon, J. J. 1839 *Ornithological biography*, 5. Edinburgh: Longman.

\* This publication was not seen before the revised text was submitted.

- Beadle, L. C. 1932 The waters of some East African lakes in relation to their fauna and flora. *J. Linn. Soc. Lond.* **38**, 156–211.
- Berlepsch, H. von & Stolzmann, J. 1906 Rapport sur les nouvelles collections ornithologiques faites au Pérou par M. Jean Kalinowski. *Ornis*, **13**, 63–133.
- Bezdek, F. H. 1946 Bird notes from El Bahira, Tunis. *Auk*, **63**, 378–381.
- Botazzi, F. 1908 Osmotischer Druck und elektrische Leitfähigkeit der Flüssigkeiten der . . . tierischen Organismen. *Ergebn. Physiol.* **7**, 161–402.
- Brown, L. H. 1955 A flamingo mystery solved. Nesting grounds of the Lesser Flamingo on an East African soda lake. *Ctry Life, Lond.* pp. 164–167.
- Cassin, J. 1855 Birds. *U.S. Naval Astr. Exped.* **2**, 172–206.
- Chapman, A. 1884 Rough notes on Spanish ornithology. *Ibis*, (5), **2**, 66–99.
- Chapman, F. M. 1908 *Camps and cruises of an ornithologist*. London: Hodder and Stoughton.
- Clarke, W. E. 1898 On the ornithology of the delta of the Rhone. *Ibis*, (7), **4**, 465–485.
- Darwin, C. 1860 *Naturalist's voyage round the world*. London: John Murray.
- Dauids, J. A. G. 1952 Étude sur les attaches au crâne des muscles de la tête et du cou chez *Anas platyrhyncha* (L.). *Proc. Kon. Ned. Akad. Wet. Amst.* (C), **55**, 81–94, 525–540.
- Dementiev, G. P. & Gladkov, H. A. 1951 *Ptitzi sovetskovo Soiuzu*, **2**. Moscow: Gosudarstvennoe Izdatel'stvo. 'Sovetskaya Nauka.'
- Domergue, Ch. 1949 Le Chott Djérid, station et lieu de ponte du Flamant rose. *Bull. Soc. Sci. nat. Tunis*, **2**, 119–128.
- Duvernoy, G. L. 1836 Mémoire sur quelques particularités des organes de la déglutition de la classe des oiseaux et des reptiles. *Mém. Soc. Hist. nat. Strasbourg*, **2**, 1–24.
- Edgeworth, F. H. 1935 *The cranial muscles of vertebrates*. Cambridge: University Press.
- Fish, G. R. 1951 Digestion in *Tilapia esculenta*. *Nature, Lond.* **167**, 900.
- Gadow, H. 1877 Anatomie des *Phoenicopterus roseus* Pall. und seine Stellung im System. *J. Orn., Lpz.* **25**, 382–396.
- Gadow, H. 1891 *Vögel*. In Bronn, *Klassen u. Ordn. d. Thierreiches*, **6**, Abt. 4, Theil 1, *Anatomisch*. Leipzig: Winter.
- Gadow, H. 1893 *Vögel*. In Bronn, *Klassen u. Ordn. d. Thierreiches*, **6**, Abt. 4, Theil 2, *Systematisch*. Leipzig: Winter.
- Gallet, E. 1949 *Les flamants roses de Camargue*. Lausanne: Librairie Payot.
- Geitler, L. 1932 *Cyanophyceae*. In Rabenhorst, L., *Kryptogamenflora*, **14**. Leipzig: Akademische Verlagsgesellschaft.
- Geoffroy, C. 1798 Sur une nouvelle espèce de Phoenicoptère ou Flammant. *Bull. Sci. Soc. philom. Paris*, **1**, pt. 2, no. 13, pp. 97–98.
- Goodall, J. D., Johnson, A. W. & Philippi, R. A. 1951 *Las Aves de Chile*, **2**, Buenos Aires: Platt Establecimientos Graficos S.A.
- Gray, G. R. 1869 Notes on the bills of the species of flamingo (*Phoenicopterus*). *Ibis*, **5**, 438–443.
- Gregory, J. W. 1896 *The Great Rift Valley*. London: Murray.
- Grew, N. 1681 *Musaeum Regalis Societatis or a Catalogue and description of the natural and artificial rarities belonging to the Royal Society and preserved at Gresham Colledge*. London: Privately published.
- Gromme, O. J. 1930 Lake Nakuru. *Yearbook 1928 Public Museum of Milwaukee*, **8**, no. 2, pp. 429–444.
- Guichard, G. 1951 Les flamants de Camargue. *Oiseau, Rev. Fr. Orn. Paris*, **21**, 48–54.
- Gundlach, J. 1875 Neue Beiträge zur Ornithologie Cubas. *J. Orn., Lpz.* **23**, 353–407.
- Halbfass, W. 1923 *Grundzüge einer vergleichenden Seekunde*. Berlin: Gebrüder Borntraeger.
- Hellmayr, Ch. E. 1932 The birds of Chile. *Field Mus. Nat. Hist. Zool.* (19), **312**, 5–472.
- Hesse, R. & Doflein, F. 1914 *Tierbau und Tierleben*, **2**, *Das Thier als Glied des Naturganzen*. Leipzig und Berlin: B. G. Teubner.
- Heuglin, M. Th. von 1873 *Ornithologie Nordost-Afrika's*, **2**. Cassel: Theodor Fischer.
- Housse, P. R. 1945 *Las Aves de Chile en su clasificacion moderna. Su vida y costumbres*. Chile: Universidad de Chile.

- Hume, A. O. 1872 *Phoenicopterus minor* Geoff: St Hil. *Stray Feathers, Calcutta*, 1, 31–35.
- Hutchinson, G. E. 1932 Notonectidae, Pleidae and Corixidae from the Rift Valley lakes in Kenya. *Ann. Mag. Nat. Hist.* (10), 9, 323–329.
- Hutchinson, G. E. 1937 A contribution to the limnology of arid regions. *Trans. Conn. Acad. Arts Sci.* 33, 47–132.
- Hutchinson, G. E. 1951 Copepodology for the ornithologist. *Ecology*, 32, 571–577.
- Huxley, J. S. 1933 *Africa View*. London: Chatto and Windus.
- Huxley, T. H. 1867 On the classification of birds; and on the taxonomic value of the modifications of certain cranial bones observable in that class. *Proc. Zool. Soc. Lond.* pp. 415–472.
- Issakov, J. A. & Formozov, A. N. 1946 Unperiodical migrations of flamingoes in the U.S.S.R. (English summary.) *Zool. Zh.* 25, 473–480.
- Jackson, Sir Frederick 1938 *The birds of Kenya Colony and the Uganda Protectorate*. London: Gurney and Jackson.
- Jenkin, P. M. 1927 The relation of *Spirostomum ambiguum* to the hydrogen ion concentration (alkaline range). *J. Exp. Biol.* 4, 365–377.
- Jenkin, P. M. 1929 Biology of lakes in Kenya. *Nature, Lond.* 124, 574.
- Jenkin, P. M. 1936 Reports on the Percy Sladen Expedition to some Rift Valley lakes in Kenya in 1929. Summary of the ecological results, with special reference to the alkaline lakes. *Ann. Mag. Nat. Hist.* (10), 18, 133–181.
- Jobert, M. 1872 Études d'anatomie comparée sur les organes du toucher, chez divers mammifères, oiseaux, poissons et insectes. *Ann. Sci. nat.* (5), 16, no. 5, pp. 1–162.
- Kappers, C. U. A., Huber, G. C. & Crosby, E. C. 1936 *The comparative anatomy of the nervous system of vertebrates, including man*. New York: Macmillan Co.
- Klingel, G. C. 1942 *Inagua*. London: Robert Hale Ltd.
- Koenig, A. 1888 Avifauna von Tunis. *J. Orn., Lpz.* 36, 121–298.
- Kripp, D. von 1933 Der Oberschnabel mechanismus der Vögel. *Morph. Jb.* 71, 469–544.
- Lambrecht, K. 1933 *Handbuch der Palaeornithologie*. Berlin: Borntraeger.
- Loveridge, A. 1923 Notes on East African birds. *Proc. Zool. Soc. Lond.* pp. 899–921.
- McCann, Ch. 1940 The flamingo (*Phoenicopterus ruber antiquorum* Temm.). *Bombay Nat. Hist. Soc.* 41, 12–38.
- Mackworth-Praed, C. W. & Grant, C. H. B. 1952 *Birds of Eastern and North Eastern Africa. African Handbook of Birds* (1), 1. London and New York: Longmans.
- Madon, P. 1932 Contribution à l'étude du régime du Flamant rose. *Alauda, Paris*, (2), 4, 37–40.
- Ménégaux, A. 1909 Étude d'une collection d'oiseaux provenant des hauts plateaux de la Bolivie et du Pérou méridional. *Bull. Soc. philom. Paris*, (10), 1, 205–229.
- Miller, A. H. 1944 An avifauna from the Lower Miocene of South Dakota. *Bull. Dep. Geol. Univ. Calif.* 27, 85–100.
- Miller, L. 1944 A Pliocene flamingo from Mexico. *Wilson Bull.* 56, 77–82.
- Miller, L. 1950 A Miocene flamingo from California. *Condor*, 52, 69–73.
- Milne Edwards, A. 1869–1871 *Recherches anatomiques et paléontologiques pour servir à l'histoire des oiseaux fossiles de la France*, 2. Paris: Masson.
- Murphy, R. C. 1936 *Oceanic birds of South America*, 1. New York: American Museum of Natural History.
- Newton, A. & Gadow, H. 1893–1896 *A dictionary of birds*. London: Adam and Charles Black.
- Niethammer, G. 1938 *Handbuch der Deutschen Vogelkunde*, 2. Leipzig: Akademische Verlagsgesellschaft.
- Owen, R. 1832a On the anatomy of the Flamingo. *Proc. Zool. Soc. Lond.* pt. II, pp. 141–144.
- Owen, R. 1832b *Memoir on the Pearly Nautilus* (*Nautilus Pompilius* Linn.). London: Royal College of Surgeons.
- Peters, J. L. 1931 *Check list of the birds of the World*, 1. Cambridge, U.S.A.: Harvard University Press.
- Philippi, R. A. 1855 Vorläufige Nachricht über einen neuen Flamingo. *Wiegmanns Arch. Naturgeschichte*, 21, 1, 10–13.

- Philippi, R. A. 1860 *Reise durch die Wüste Atacama*. Halle: Edward Anton.
- Philippi, R. A. 1888 Ornithologie der Wüste Atacama und der Provinz Tarapacá. *Ornis*, **4**, 155–160.
- Philippi, R. A. 1902 Figuras i descripciones de Aves Chilenas. *An. Mus. nac. Chile*, **15a**, 1st sect., Zool., pp. 1–114.
- Plate, L. 1922 *Allgemeine Zoologie und Abstammungslehre*, **1**. Jena: Verlag Fischer.
- Plate, L. 1924 *Allgemeine Zoologie und Abstammungslehre*, **2**. Jena: Verlag Fischer.
- Poncy, R. 1926 Biologie et migration du Flamant rose, *Phoenicopterus ruber antiquorum*. *Bull. Soc. Zool. Genève*, **3**, 5, 4–33.
- Rahmer, C. 1886 Descripción de una nueva especie de Flamenco de la provincia de Tarapacá. *An. Univ. Chile*, **69**, 753–755.
- Rahmer, C. 1887 Briefliches über *Phoenicopterus jamesi* Rahm. *J. Orn.*, *Lpz.* **35**, 160–162.
- Rich, F. 1932 Phytoplankton from the Rift Valley lakes in Kenya. *Ann. Mag. Nat. Hist.* (10), **10**, 233–262.
- Ridgway, R. 1896 *Manual of North American Birds*. Philadelphia: J. B. Lippincott Co.
- Ridley, M. W. 1954 Observations on the diet of flamingoes. *J. Bombay Nat. Hist. Soc.* **52**, 5–7.
- Ridley, M. W., Moss, B. L. & Percy, Lord R. C. 1955 The food of flamingoes in Kenya Colony. *J. E. Africa Nat. Hist. Soc.* **22**, 5, 147–158.
- Ridley, M. W. & Percy, Lord R. C. 1953 Notes on the birds of Lake Elmenteita, Kenya Colony. *Proc. Univ. Durham Phil. Soc.* **12**, 103–118.
- Roberts, A. 1935 Birds. In Scientific results of the Vernay-Lang Kalahari expedition, March to September 1930. *Ann. Transv. Mus.* **16**, 1–185.
- Romer, A. S. 1945 *Vertebrate palaeontology*, 2nd ed. Chicago: University of Chicago Press.
- Rudolph, W. E. 1951 Chuquicamata twenty years later. *Geogr. Rev.* **41**, 88–113.
- Salvadori, T. 1895 *Catalogue of the birds in the British Museum*, **27**. London: British Museum.
- Schildmacher, H. 1931 Untersuchungen über die Funktion der Herbstschen Körperchen. *J. Orn.*, *Lpz.* **79**, 374–415.
- Sclater, P. L. 1886 List of a collection of birds from the Province of Tarapacá, northern Chile. *Proc. Zool. Soc. Lond.* pp. 395–404.
- Sclater, P. L. & Hudson, W. H. 1889 *Argentine ornithology*, **2**. London: R. H. Porter.
- Sharpe, R. B. 1875–1884 *Layard's 'The Birds of South Africa' revised*. London: Quaritch.
- Shufeldt, R. W. 1901 Osteology of the flamingoes. *Ann. Carneg. Mus.* **1**, 295–324.
- Stadtmüller, F. 1938 Zunge, Mundhöhleboden. In Bolk, L., Göppert, E., Kallius, E. & Lubosch, W., *Handbuch der vergleichenden Anatomie der Wirbeltiere*, **5**. Berlin und Wien: Urban und Schwarzenberg.
- Stejneger, L. 1885 Editor of Kingsley, J. S., *Standard natural history*, **4**, *Birds*. Boston, Mass.: S. E. Cassino and Co.
- Stresemann, E. 1927–1934 Aves. In Kukenthal, W., *Handbuch der Zoologie*, **7**, 2. Berlin: Walter de Gruyter und Co.
- Tenison, W. P. C. 1954 Aves. *Zool. Rec.* **89**, sect. 17, pp. 1–88.
- Ticehurst, C. B. 1923 The birds of Sind. V. *Ibis*, (11), **5**, 438–474.
- Van Someren, U. G. L. 1922 Notes on the birds of East Africa. *Novit. zool.* **29**, 1, 1–246.
- Walcott, F. C. 1925 An expedition to the Laguna Colorada, Southern Bolivia. *Geogr. Rev.* **15**, 345–366.
- Watts, W. A. 1941 Flame-feathered flamingoes of Florida. *Nat. Geogr. Mag.* **79**, 56–65.
- Wetmore, A. 1926 Observations on the birds of Argentina, Paraguay, Uruguay and Chile. *Bull. U.S. Nat. Mus.* **133**, 1–448.
- Witherby, H. F., Jourdain, F. C. R., Ticehurst, N. F. & Tucker, B. W. 1939 *The Handbook of British Birds*, **3**. London: H. F. and G. Witherby Ltd.
- Yeates, G. K. 1950 *Flamingo City*. London and New York: Country Life Ltd.
- Young, J. Z. 1950 *Life of vertebrates*. Oxford: Clarendon Press.
- Zahl, P. A. 1953 *Flamingo hunt*. (1st English edition) London: Hammond, Hammond and Co.
- Zander, E. 1908 Sieb- und Filterapparate im Tierreiche. *Z. Naturw.* **80**, 39–90.



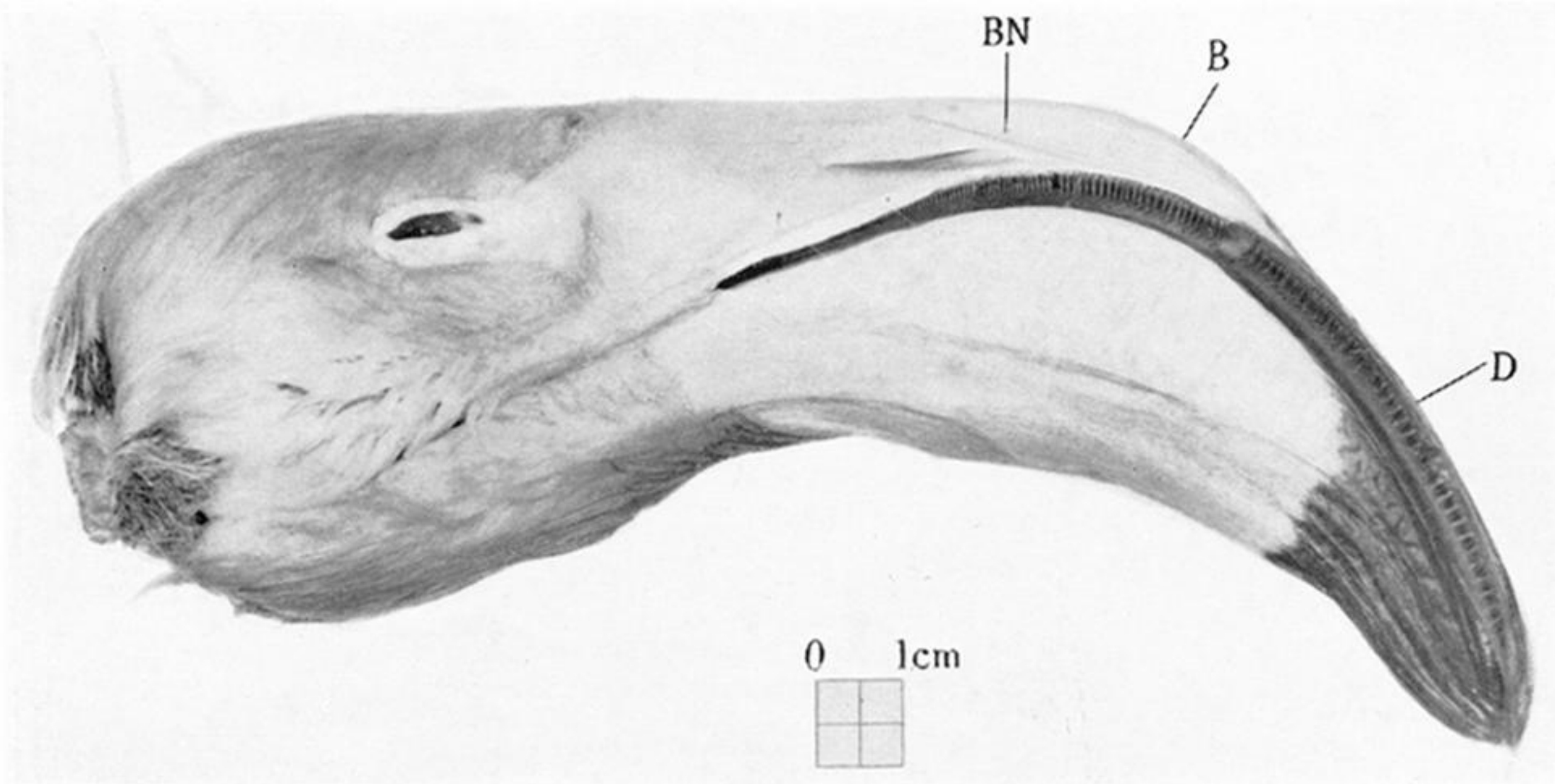
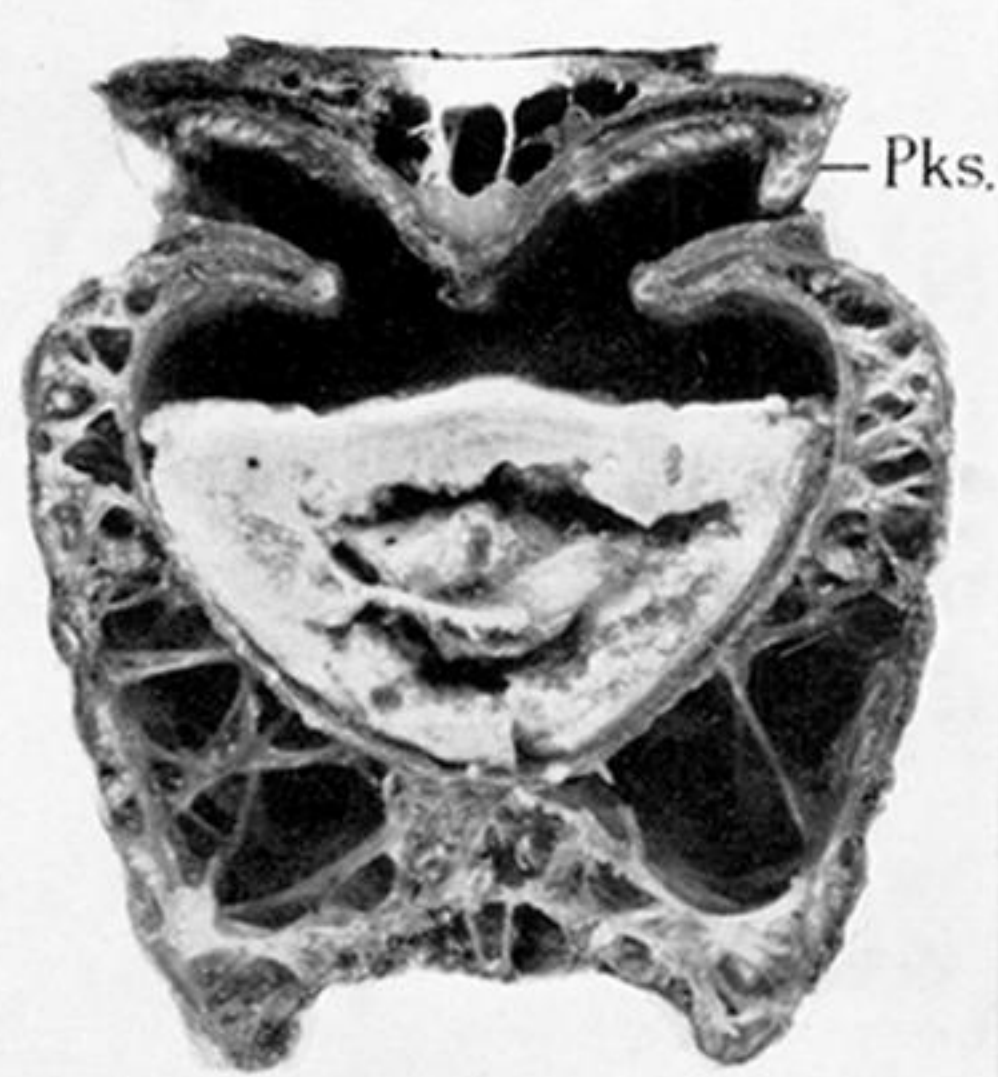

FIGURE 20



FIGURE 21



0 0.5 1cm  
scale for sections

FIGURE 22

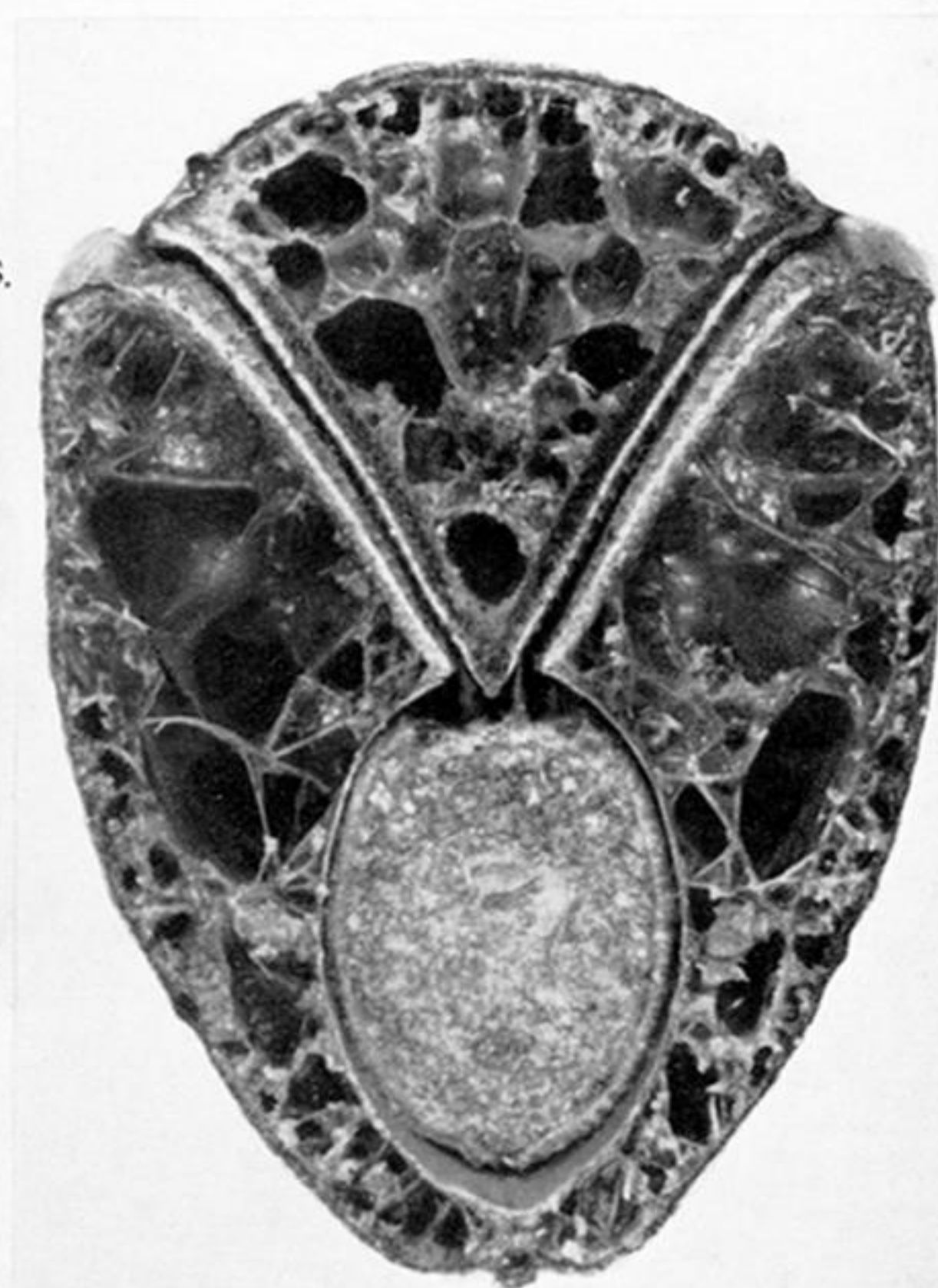

FIGURE 24

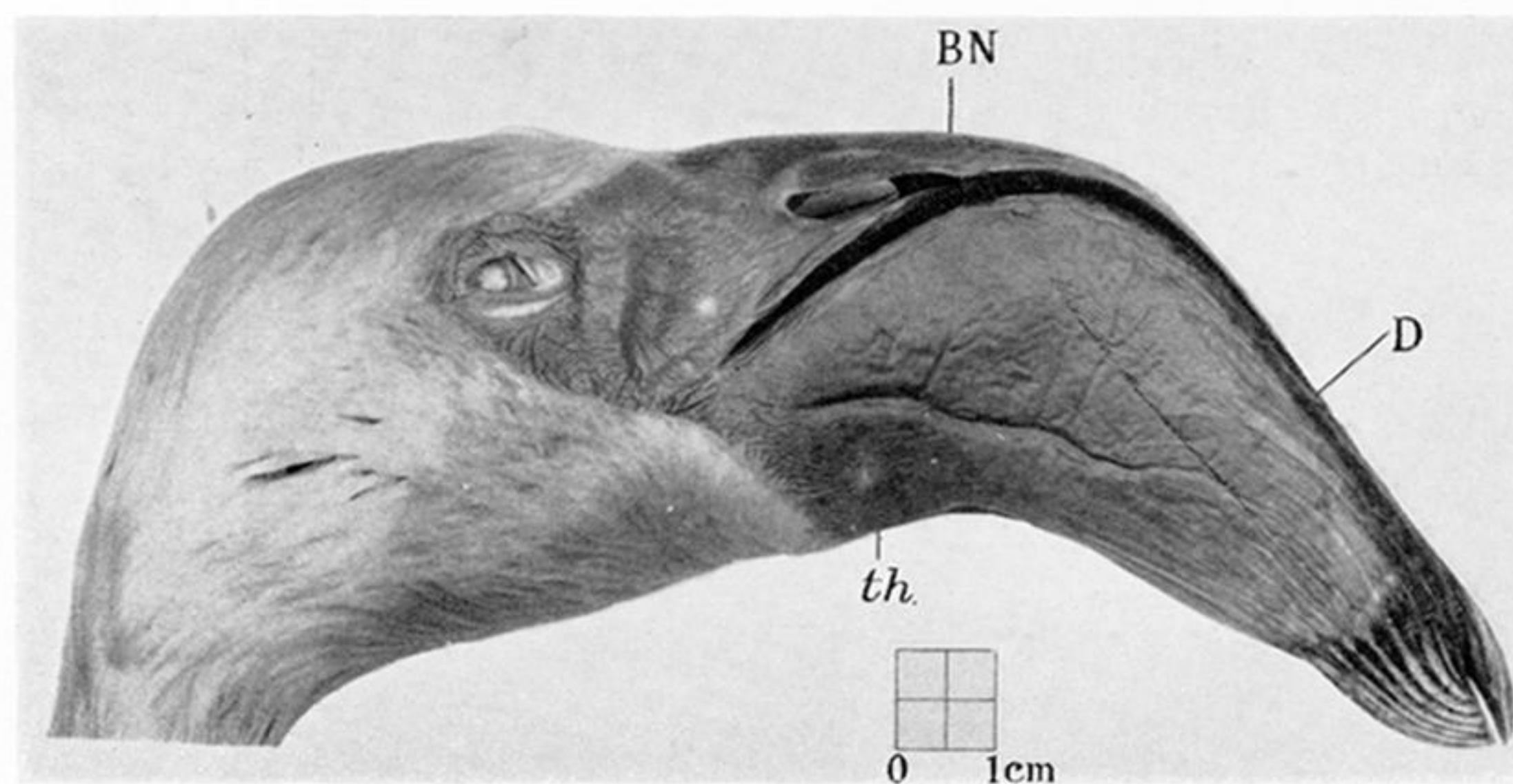

FIGURE 23

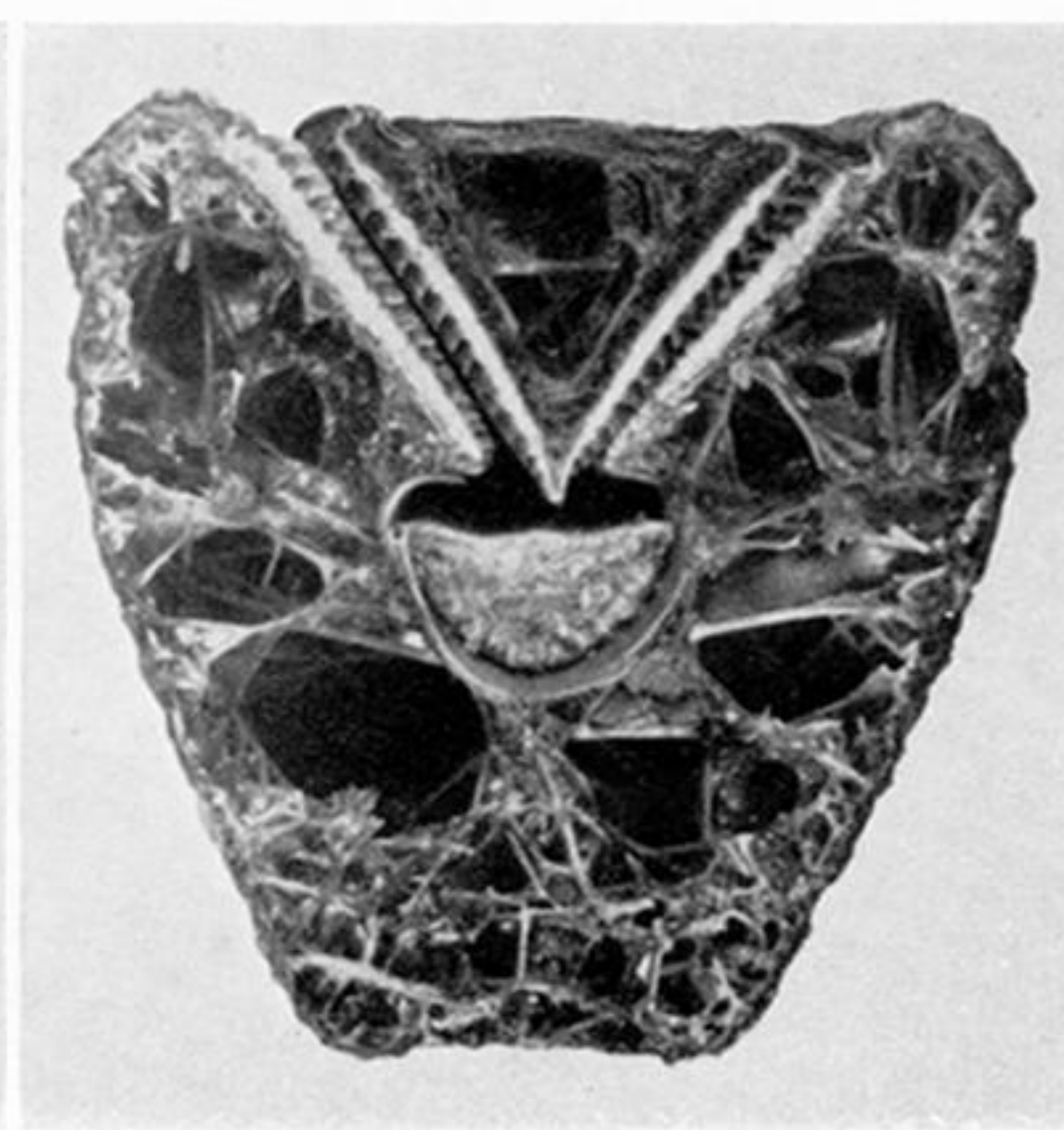

FIGURE 25

#### DESCRIPTION OF PLATE 14

FIGURE 20. *Ph. antiquorum*. Profile of adult, J3, with bill not quite as fully closed as possible. The marginal hooks and leaflets are clearly visible on the upper jaw (a group have been removed just distal to the bend, B).

FIGURE 21. *Ph. antiquorum*. Transverse section at BN (figure 20). The tongue is large and carries large recurved spines; its hyoid skeleton is nearly central; marginal leaflets, Pls, cross the gape (cf. figures 2 and 8b).

FIGURE 22. *Ph. antiquorum*. Transverse section at D (figure 20). The inrolling of the marginal hooks, Pks, can be seen to prevent complete closing of the gape. The inner platelets are visible on the concave lamellated area of the upper jaw (cf. figure 8a).

FIGURE 23. *Ph'naias minor*. Profile of adult male, R792. The bony stiffening of the 'throat', th., in front of the feathers, shows well in contrast to the soft skin in *Ph. antiquorum*, figure 20 above.

FIGURE 24. *Ph'naias minor*. Transverse section at BN, showing relatively small tongue and deep, flattened lamellated areas (cf. figure 11).

FIGURE 25. *Ph'naias minor*. Transverse section at D, showing the upper jaw sunk between the expanded borders of the lower jaw (cf. figure 12).



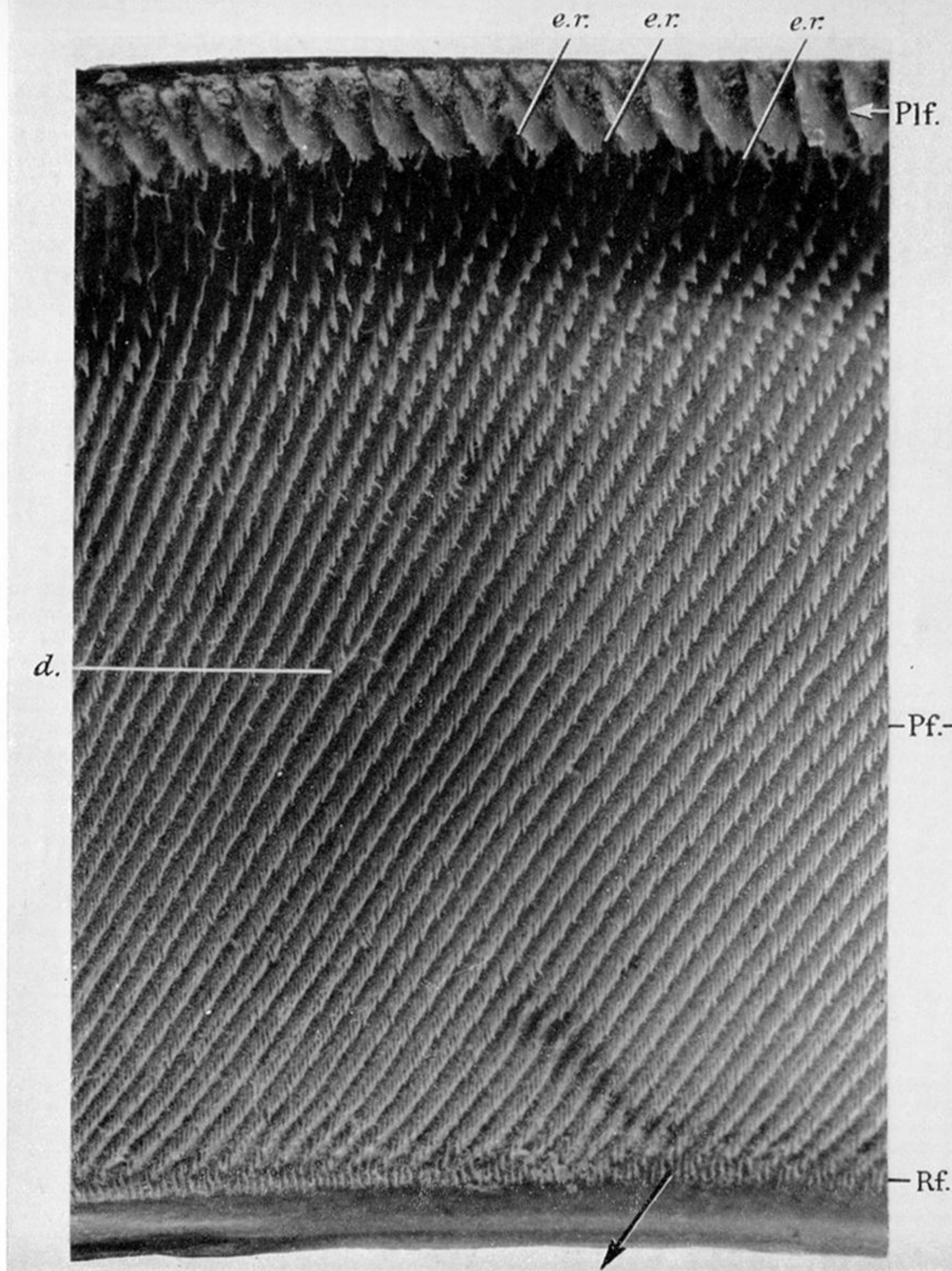

FIGURE 27. *Ph'naias minor*. Surface view of maximum width of lamellated area of *upper jaw* at BN, with fringed marginal leaflets and proximal inner platelets, very much smaller than those on the distal part of the bill in figure 26. The magnification is the same.

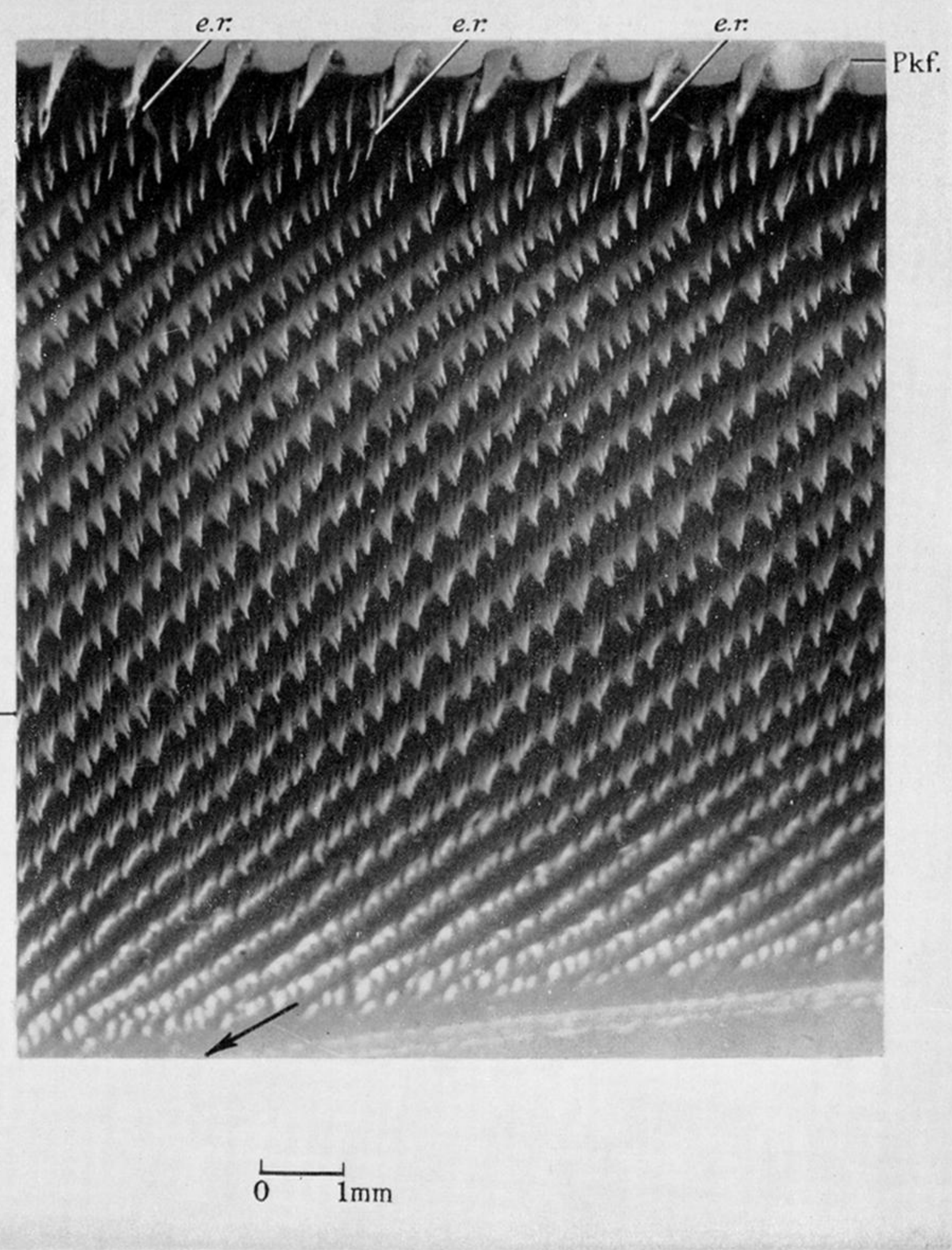

FIGURE 26. *Ph'naias minor*. Surface view of the whole width of the lamellated area of *upper jaw* at D, with marginal hooks at the ends of diagonal rows of fringed platelets (see below for orientation).

*d.* point where two diagonal rows converge; *e.r.* extra diagonal rows, not ending at a marginal platelet; Pkf, fringed marginal hook; Pif, fringed marginal leaflet; Pf, fringed platelet; Rf, fringed ridge.

The photographs in plates 15, 16 and 17 are surface views of different parts of the lamellated areas lining the bills of flamingoes; all are from the right-hand side of the bill; all are equally magnified ( $\times 10$ ); and all are orientated so that the tip of the bill is towards the top of the page. Photographs taken nearest the tip are also at the top. The margin of the upper jaws is to the left, and of the lower to the right; so that if, for instance, plates 15 and 16 are brought together they will be orientated to one another as they would be across the gape in the bird's bill. Plate 17 would have to be folded down the middle to achieve this. For explanation of arrows pointing towards the tongue, see text (pp. 475 et seq.).



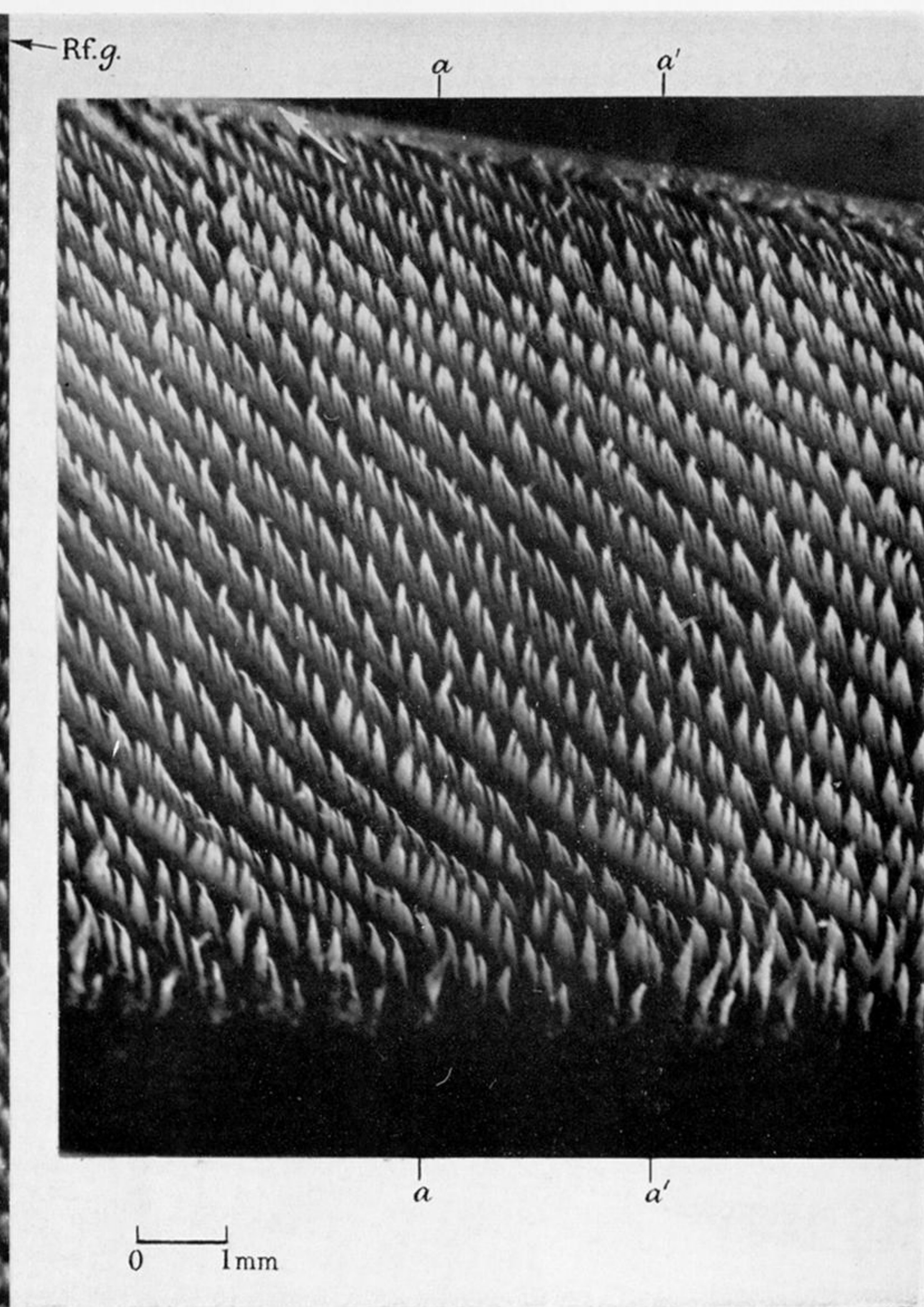
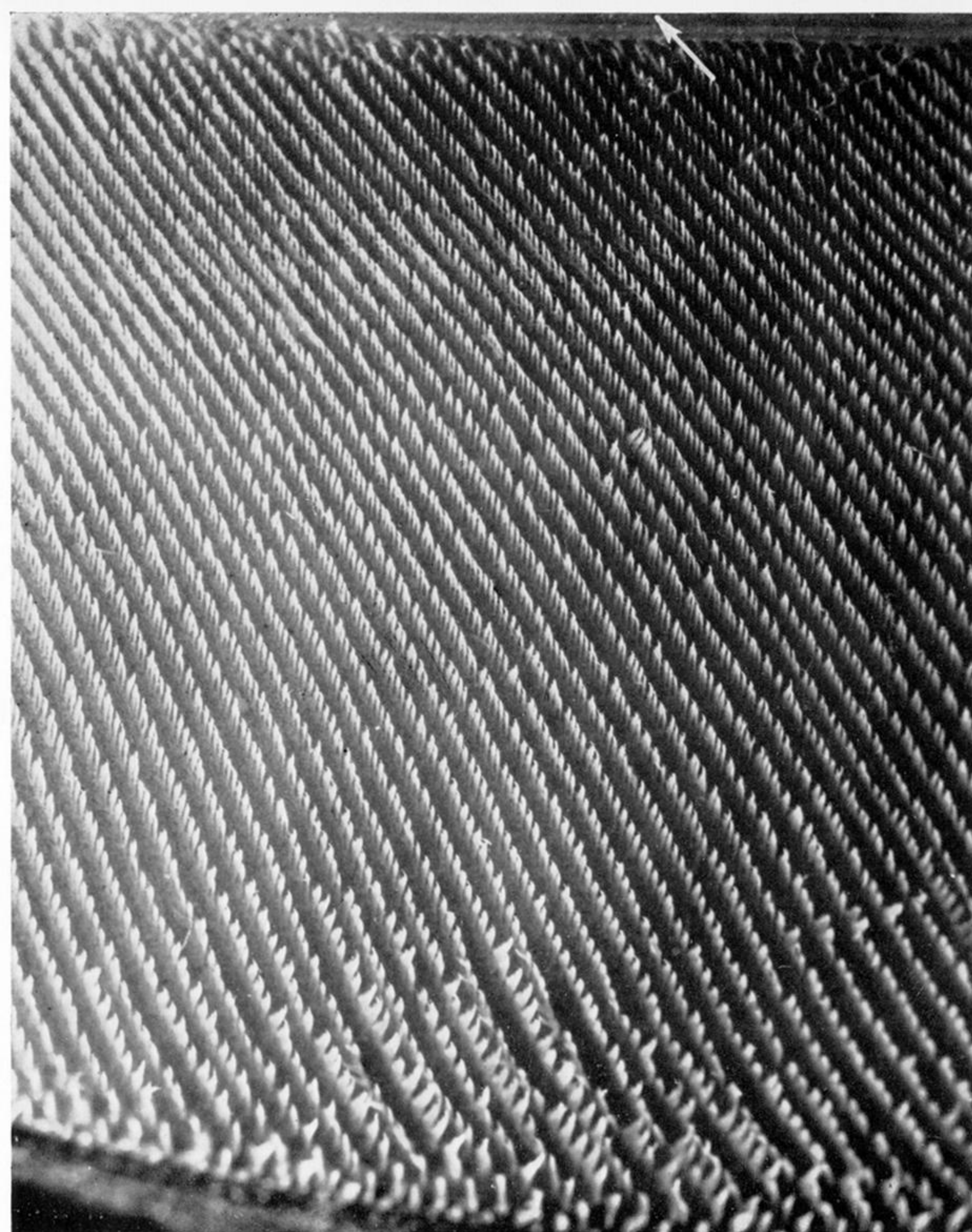
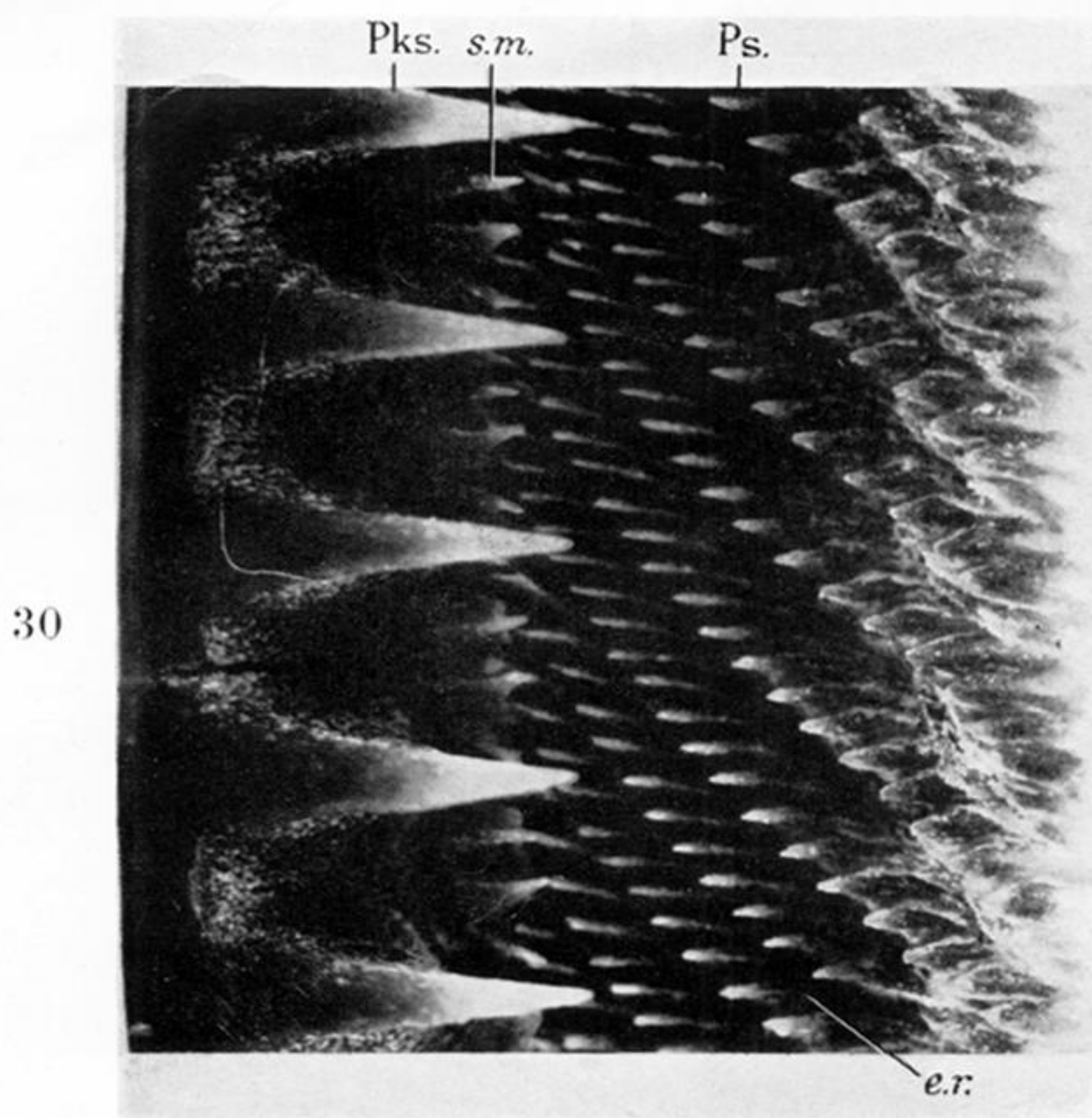

FIGURE 29. *Ph'naias minor*. Surface view of the *lower jaw* at BN', with small proximal inner platelets (cf. figure 27, taken from the corresponding region of the upper jaw). Rf.g., the collecting trough on the median edge, formed by a longitudinal fringed ridge (cf. figure 11).

FIGURE 28. *Ph'naias minor*. Surface view of the whole width of the lamellated area of the *lower jaw* at D' (orientation as in plate 15). A strip 2 mm wide, between *aa* and *a'a'* is analyzed in text figure 15.





30

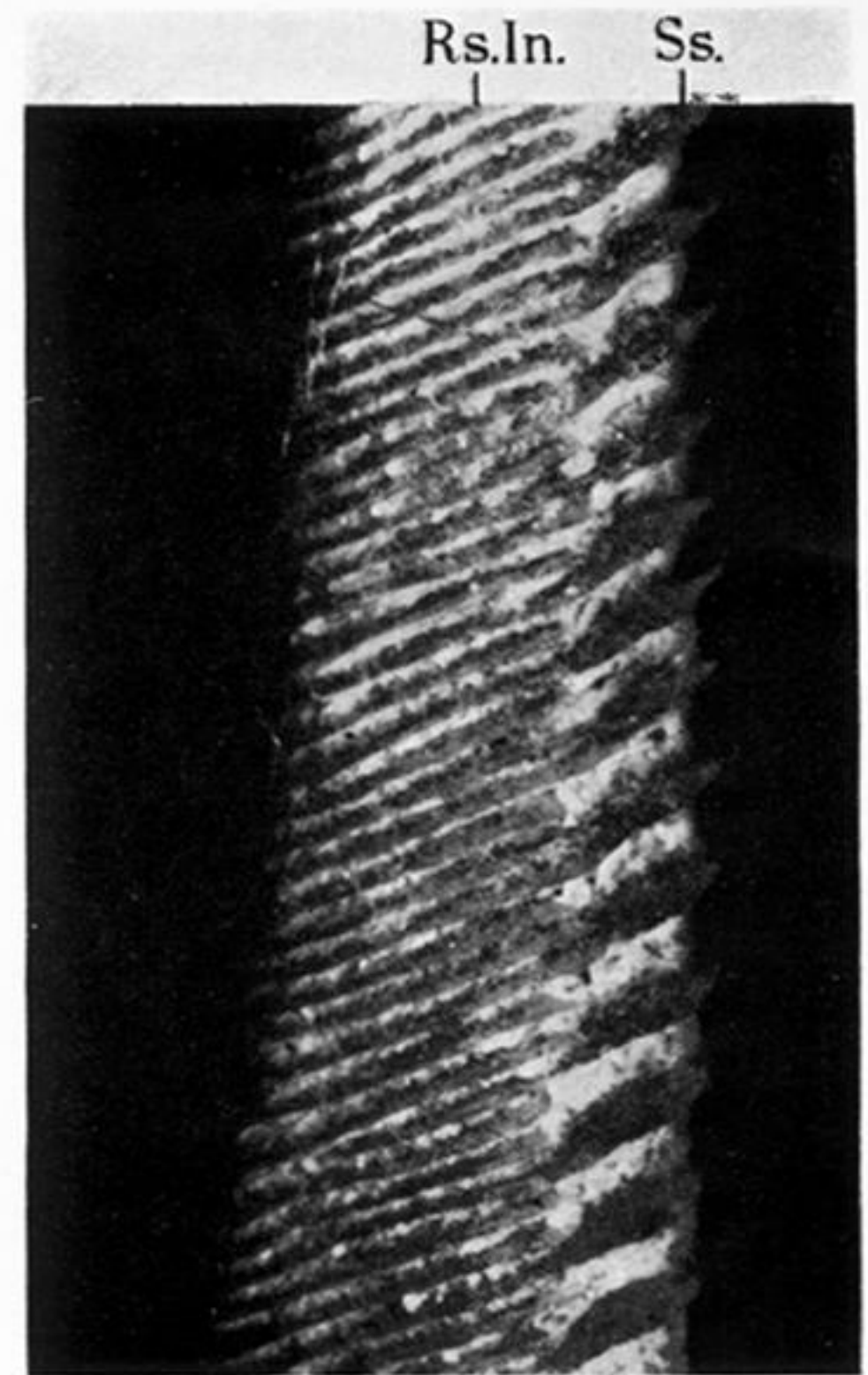

32

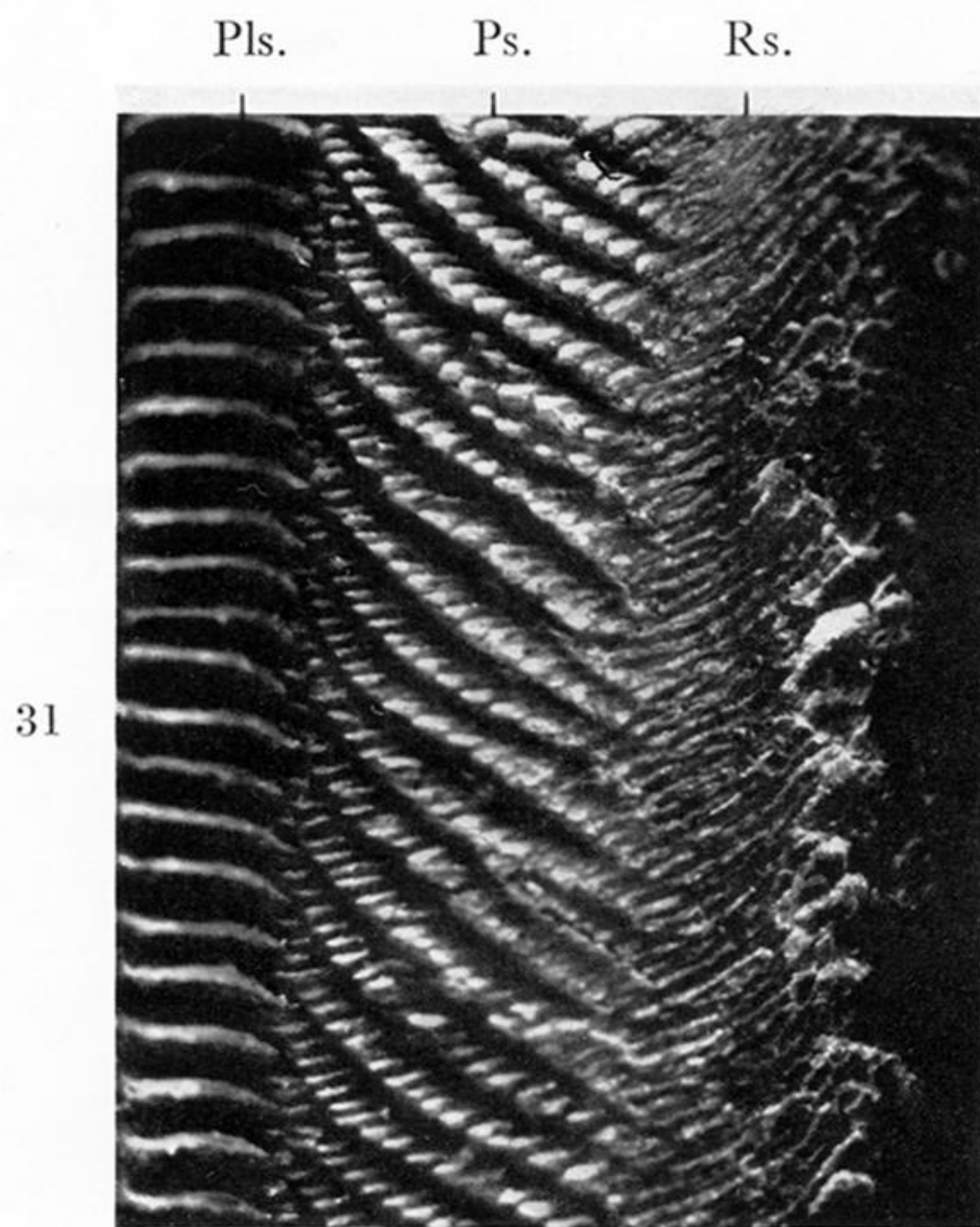

31

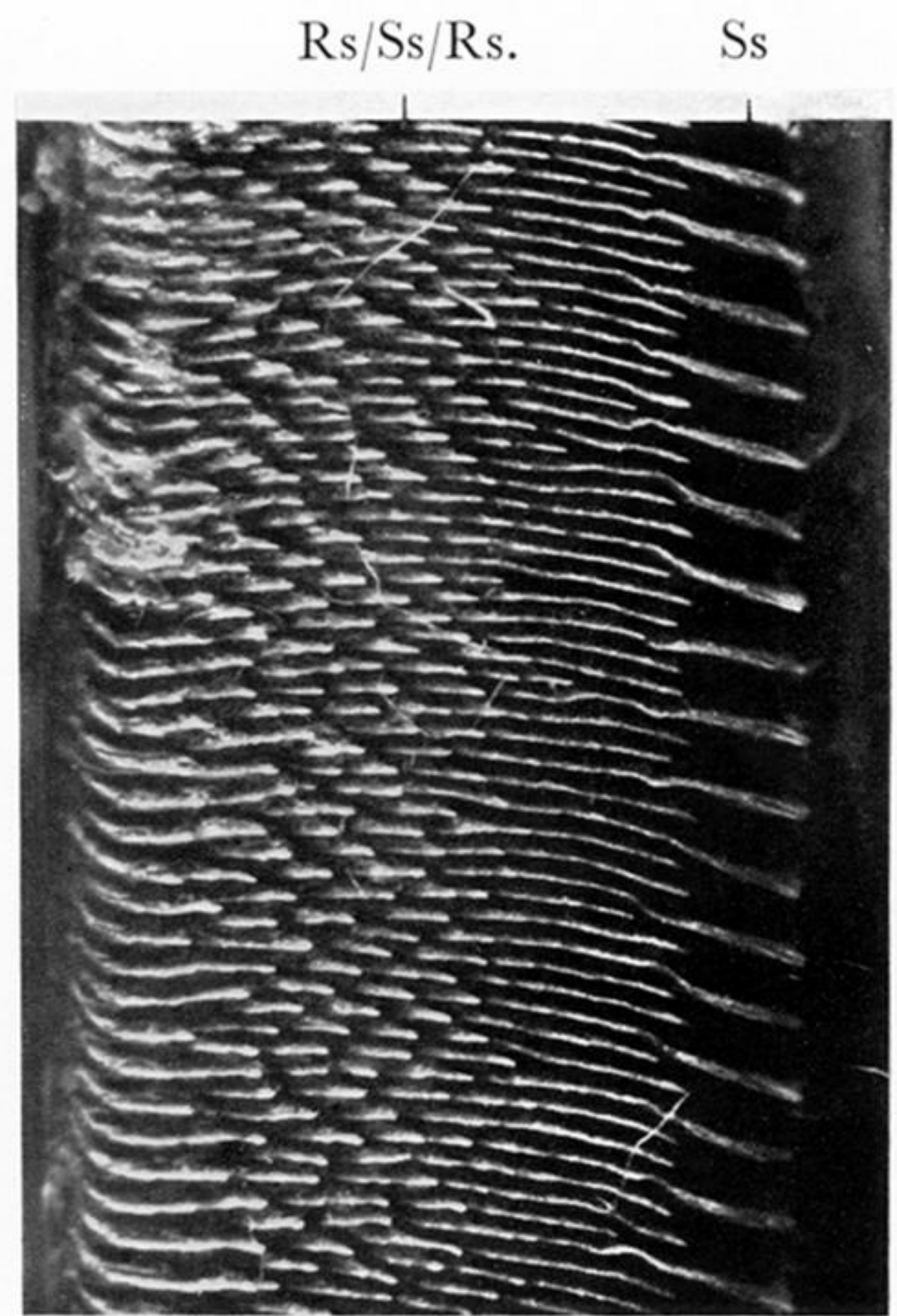

33

Lamellae of *Ph. antiquorum*. The magnification ( $\times 10$ ) and orientation are the same as in plates 15 and 16. Lateral margins are to the sides, and median edges to the centre of the page.

FIGURE 30. Surface view of the whole width of the lamellated area of *upper jaw* at D. The smooth marginal hooks, Pks, tend to obscure the submarginals, *s.m.*, which are considerably farther from the camera. The inner platelets, Ps, are large here, as in figure 10*a*; they form diagonal rows and an extra row, *e.r.* A similar area is analyzed in figure 9.

FIGURE 31. *Upper jaw* at BN, with close-set marginal leaflets, Pls, and inner lamellae slanting across the area and forming some platelets, Ps, but persisting medially as smooth ridges, Rs.

FIGURE 32. *Lower jaw* at D', with smooth inner lamellae forming ridges, Rs.In. Outer lamellae here, and in figure 33, are serrated, Ss (cf. figure 10*b*), but the peaks do not show as they come towards the camera (cf. figures 8*a* and 22, plate 15).

FIGURE 33. *Lower jaw* at BN', showing partially serrated inner lamellae, Rs/Ss/Rs, with the peaks roughly aligned diagonally; there are two or three between adjacent outer lamellae, Ss.